

# DDCS-V4.1

## Standalone Motion Controller Users Manual V1

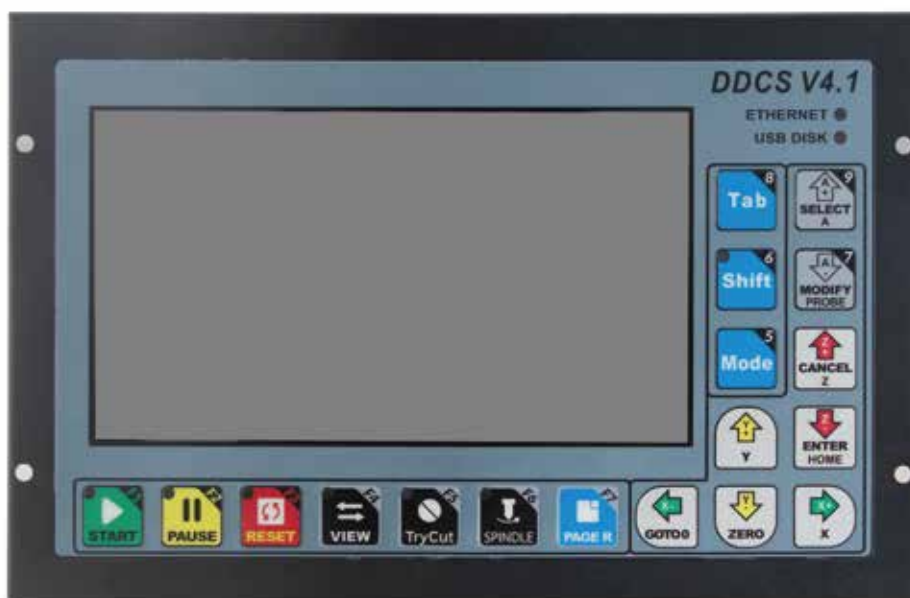

This Manual based on:  
Software Version: 2022-05-29-001-NOR  
Manual updated at 14th. Sep. 2022

All copyrights reserved  
Shall not be reproduced without permission.

**深圳市众联拓数控科技有限公司**  
Shenzhen Digital Dream Numerical Technology Co., Ltd.

# Contents

1	Controller Brief Introduction	4
1.1	DDCS V4.1 Product Introduction	4
1.2	DDCS V4.1 Brief technical feature	5
1.3	Appearance, Structure and Size of Product	7
1.4	Software Structure	9
1.5	Explanation of Abbreviations	10
1.6	Notes and Warnings	10
2	Wiring	11
2.1	DDCS V4.1 Wiring Board	11
2.2	DDCS V4.1 Power Supply Input	14
2.3	DDCS V4.1 Stepper/Servo Control Output	15
2.4	DDCS V4.1 Spindle control outputs	17
2.5	Input Ports (IN01-IN18) Wiring	19
2.5.1	Limit, Home and Probe Input ports	19
2.5.2	DDCS V4.1 Extended Function Inputs	21
2.5.3	DDCS V4.1 MPG Wiring	22
2.5.4	View Page	24
3	Software and operation	25
3.1	DDCS V4.1 Key definition	25
3.2	DDCS V4.1 Interface description	28
3.2.1	Main Page	28
3.2.2	FRO	33
3.2.3	SRO	33
3.2.4	JSR	33
3.2.5	F Feeding speed	34
3.2.6	S Spindle speed	35
3.2.7	Coordinate system management	36
3.2.8	Tool management	37
3.3.9	M5/M9/M11	37
3.3	Menu function on the Main page	38

3.3.1	Goto Zero	39
3.3.2	Zero	39
3.3.3	Home	40
3.3.4	Probe	41
3.3.4.1	Floating Probe	41
3.3.4.2	Fixed probe	42
3.3.4.3	Vertex Probe	43
3.3.4.4	Tool length (H) Measurement	46
3.3.5	Advanced machining	48
3.3.5.1	Advanced startup	49
3.3.5.2	Array machining	49
3.3.5.3	Sequence machining	50
3.3.5.4	Milling Plane Machining	51
3.3.5.5	Milling cylindrical machining	52
3.3.6	Bias Management	52
3.3.7	Breakpoint	54
3.3.8	Multiple Coordinate origin	55
3.3.9	Centers	56
3.3.10	Simulation	57
3.4	File Management Page	58
3.4.1	File Management Page Introduction	58
3.4.2	Build the Ethernet communication	59
3.4.3	Software Update	70
3.5	Parameters Management Page	74
4	Parameter Instruction	76
5	G Code and M Code	87
6	Questions and Answer	90
	Appendix 1 Keyboard Mapping	92

The copyright of the manual belongs to Shenzhen Digital Dream Numerical Technology Co., Ltd. (herein after referred as Digital Dream Company). This manual and any image, table, data or other information contained in this manual may not be reproduced, transferred, or translated without any prior written permission of Digital Dream Company.

The information contained in this manual is constantly being updated. You can login to the official website of Digital Dream Company [www.ddcnc.com](http://www.ddcnc.com) to download the latest PDF edition for free.

# 1 Controller Brief Introduction

## 1.1 DDCS V4.1 Product Introduction

Thank you for your interest in our standalone motion controller and for taking the time to read this manual.

Digital Dream is a numerical control company specializing in the research, development and production of various CNC (Computer Numerical Control) systems since 2008. Digital Dream aims to combine high quality and high reliability with affordability.

The DDCS V4.1 3-4 axes motion controller for stepper and servo system, is updated from DDCS V3.1 on software and hardware. It combines great advancement with tiny footprint of each days from past 8 years, when we released the first DDCS products DDCS V1.1. After a very short time you will be familiar with the functions and this manual will help you.

The DDCS numerical control system adopts the ARM+FPGA design framework. ARM controls the human-computer interface and G-code analysis and the FPGA provides the underlying algorithms and creates the control pulse. This guarantees reliable control and easy operation. The internal operating system is Linux based.

The panel layout structure of the DDCS V4.1 is very rational to save space. All operations are controlled by only 17 keys and the keys are composite keys that can act as function keys or numeric keys. DDCS V4.1 support comprehensive Fanuc G code set.

The DDCS can be used for many styles and types of CNC machines. Lathes, Routers, Pick&Place and Mills are just a few examples. The DDCS operates as a Stand Alone system without the need of a computer. This guarantees high precision, accuracy and reliability. The interface, even though very comprehensive, can be learned in a very short time.

## 1.2 DDCS V4.1 Brief technical feature:

- 1) 18 photoelectric isolated digital inputs, 3 photoelectric isolated digital outputs.
- 2) The spindle can be configured as Analog spindle (0~10V) and also Servo spindle.
- 3) 3-4 axes motor Control. Differential Mode and Double Pulse Mode output signal for optional, Maximum interpolation pulse output frequency is 500KHz/Axis, 2-4 Axis linear interpolation, any 2 axis circular interpolation;
- 4) ARM9 main control chip, FPGA core algorithm chip.
- 5) 7 inches TFT screen, Size: 1024x600 Pixels, Resolution: 72 Pixels/Inch; 17 operation keys.
- 6) The Power Supply for IO Port is 24VDC, minimum current is 0.5A, the Power Supply for Controller system is also 24VDC, minimum current is 0.5A. Controller needs both power to work properly.
- 7) USB flash disk support for G code file input; Can transfer the files by Ethernet communication between the computer and DDCS V4.1 controller; No size limited of the G-code file.
- 8) Compatible with standard G-code, support popular CAD/CAM software, such as ArtCam, MasterCam, ProE, JDSOFT SurfMill, Aspire, Fusion 360 and so on;
- 9) Support standard MPG.
- 10) Support function of "Try cutting" (handwheel guiding) function.
- 11) Support Jog function for each axis (continuous, step, defined distance), Customer can define the distance.
- 12) Support Float Probe, Fix Probe, Vertex Probe and Tool Length Measurement.
- 13) Support the operation of quickly go to specify line and closest position.
- 14) Support Array Machining, Sequence Machining, Milling Plane Machining, and Milling cylindrical machining.
- 15) Support Bias for XYZA axis, and can define the Bias distance.
- 16) Support Pause breakpoint, Power-Cut Recovery Breakpoint and loaded breakpoint; And Support Start from the specific line and closest line.
- 17) Support Multiple origin points operation, the users can create an origin point and load it.
- 18) Support Find Middle for X and Y axis.
- 19) Improved the simulation function. During the simulation, you can adjust the FRO and observe whether the programming path meets the expectations and check the soft limits. During the simulation, it can be paused, and when press the Start key again, the system will continue to simulate from the pause breakpoint.
- 20) Slave X, Slave Y Or Slave Z, for Gantry machine with two independent motors on main axes.

21) Now English and Chinese language is available; System also support International coding, almost support all language, the users can add their own language to the control system.

22) DDCS V4.1 Only Supports NPN Type Limited Switch.

23) Support 4 kinds operation rights: visitor, operator, admin, super admin.

## **DDCS V4.1 New features compared to previous version:**

1) Added USB port and Ethercat Port on DDCS V4.1.

2) Slave X, Slave Y Or Slave Z, for Gantry machine with two independent motors on main axes.

3) Added Servo Spindle option.

4) Add Polar coordinate programming commands and Rotation commands, and completed Radius compensation commands on DDCS V4.1 controller.

5) DDCS V4.1 controller upgrades the motion algorithm, by Machining profile accuracy configuration, makes a long g-code program with short line segments running smoother.

6) No matter how big program file it is, system can quickly active the function of Start from Specified line and Start from closest point in few seconds.

7) Improve the simulation function. During the simulation, you can adjust the FRO and observe whether the programming path meets the expectations and check the soft limits. During the simulation, it can be paused, and when press the Start key again, the system will continue to simulate from the pause breakpoint.

8) DDCS V4.1 added driver alarm input ports, and can configurate the ports No.as you want. Same as DDCS-Expert.

9) We add cycle encoder for A axis, which is good for unlimited rotation for A axis.

10) Added the window for analysis prompt.

11) Support International coding, almost support all language, the users can add his language for the control system.

12) Increased the Parameters about the acceleration when Estop, to avoid collision by Stop when Estop the machine in high speed, edit the related parameters and system can give a smooth stop, this means there is no position loss.

13) System FPGA cited 32 -bit speed generator, with higher resolution for the speed / acceleration, it means higher positioning accuracy.

## 1.3 Appearance, Structure and Size of Product



Figure 1-1 DDCCS V4.1 Front panel



Figure 1-2 DDCCS V4.1 Back Side of the controller

The DDCCS V4.1 is a small box that can fit in a window of a small control box or control cabinet. Four locking hooks fix this controller from the frame. The dimension you find in Figure 1-3.

The front panel is 237 mm \* 153.7 mm \* 5.2 mm ;

The main body is 237 mm \* 153.7 mm \* 48.2 mm ;

To mount the unit in an equipment cabinet, cut the hole 228.5 mm \* 83.7 mm.

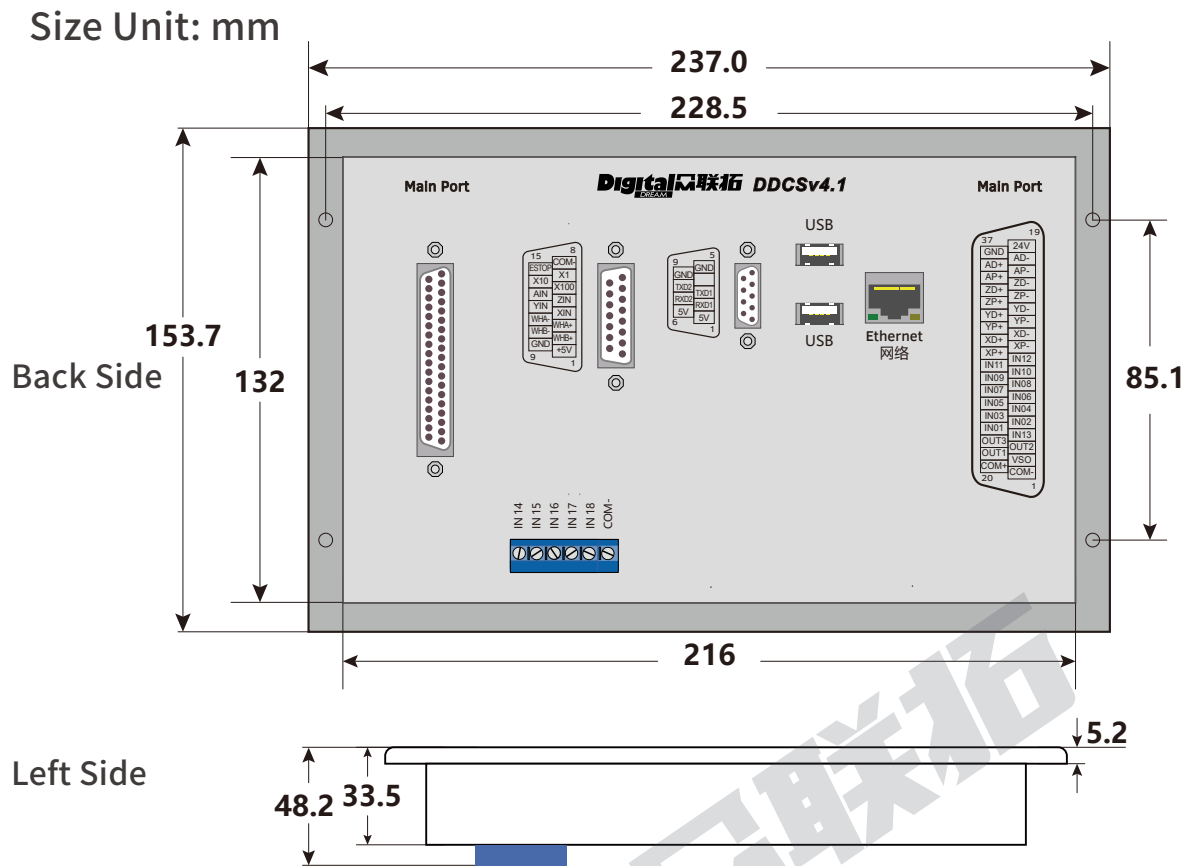

Figure 1-3 DDCS V4.1 Back view, Side view and dimensions

Accessories:

1) The Wiring Board for DDCS V4.1 and DDCS V3.1; 2) DB37 Cable, for the wiring between the board and DDCS V4.1 controller, 3 meters; 3) USB Extension cable 50cm; 4) USB stick; 5) screws.



Figure 1-4 DDCS V4.1 Main controller and accessories



# 1.4 Software Structure

## DDCSV4.1 Software structure diagram

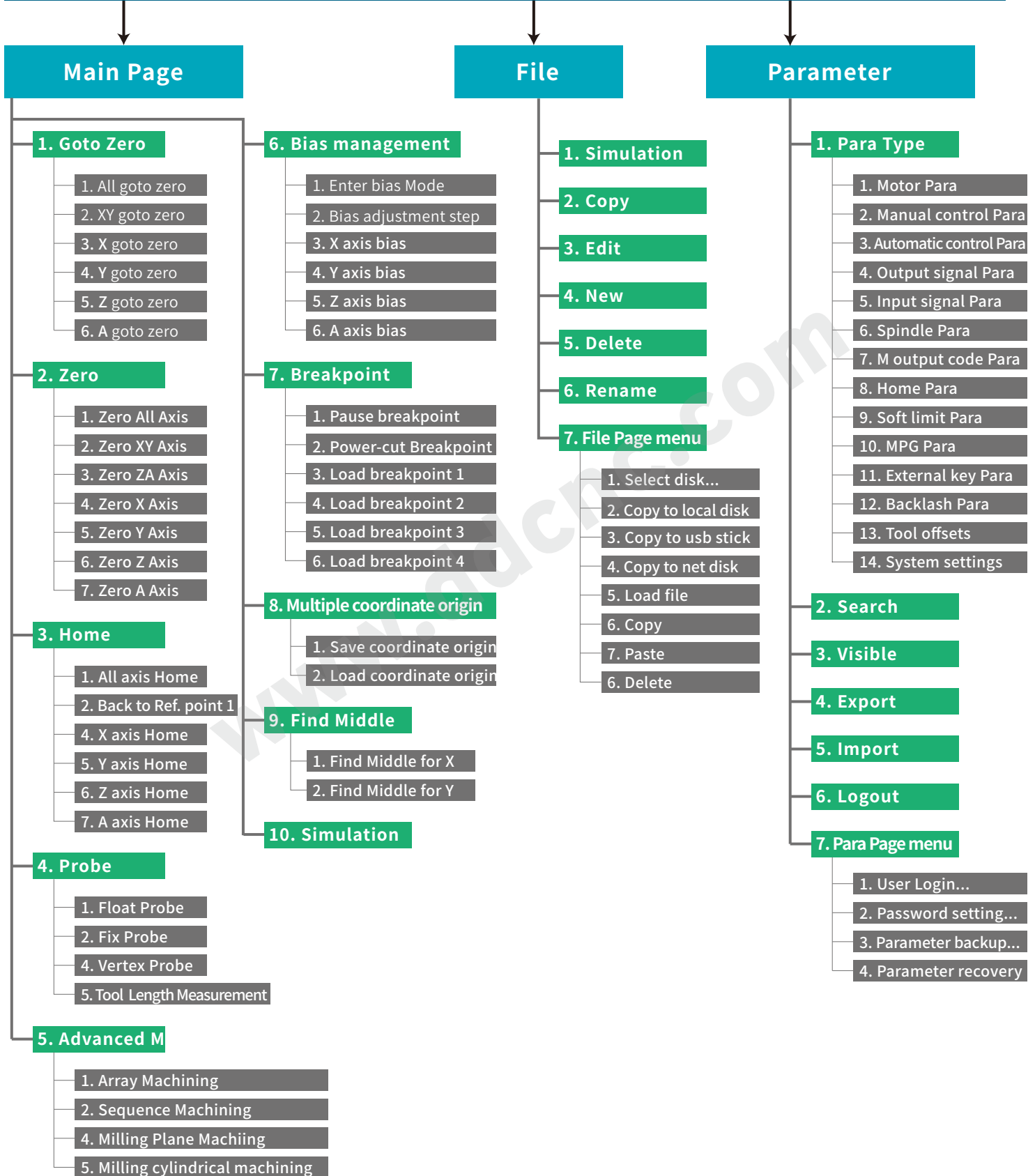

Figure 1-5 DDCS V4.1 Software Structure

## 1.5 Explanation of Abbreviations

When operating the DDCS, the users will come across some English abbreviations. Here a list with explanations

FRO: Feed Rate Override

SRO: Spindle Rate Override

SJR: Jog Speed Setting

F: Feed rate, unit is mm/min

S: Spindle Speed, unit rev/min.

X: The coordinate code of the X axis.

Y: The coordinate code of the Y axis.

Z: The coordinate code of the Z axis.

A: The coordinate code of the A axis

BUSY: The system is busy. You still can adjust FRO and SRO

READY: READY mode, any operation can be done

RESET: Reset mode, controller is in “ OFF” mode, no operation can be performed

CONT: Continuous mode, each axis can be manually jogged with the arrow keys

Step :Manual Step Mode, each axis can be jogged in defined steps

MPG: MPG mode. Operate the machine with the MPG (Manual Pulse Generator)

AUTO: Run G code. Auto is showing when file is processing

## 1.6 Notes and Warnings



Keep away from exposure to moisture or water. This product contains sophisticated electronics and must not get wet.

Wiring warning: the IO input terminal of this controller supports equipment with source-power (such as Inductive Proximity Switch ). When using this kind of equipment, pay attention to the polarity. Avoid the +terminal to be connect with GND. This controllers has analog output for spindle control (0-10V). Please avoid this terminal to ever connect with GND as damage to the controller may occur.



Operation warning. Please observe all security measures when operating the machine. The ESTOP must be connected and properly labelled. In case of a problem, press the E-stop at once to avoid damage to humans, animals and the equipment .



High voltage danger. The DDCS is connected to 24V DC. Obey and follow the electricity safety rules of your country when connecting this equipment.

## 2 Wiring

### 2.1 DDCS V4.1 Wiring Board

In order to facilitate engineers to install controller into the control cabinet, DDCS V4.1 provides a wiring terminal board. The wiring board is connected to the controller host through DB37 shielded cable. There are screw fittings at the interface, which is very firm and reliable.

The user can install the wiring board in the control cabinet with the matching C45 guide rail, the size of the guide rail is shown in the following figure.

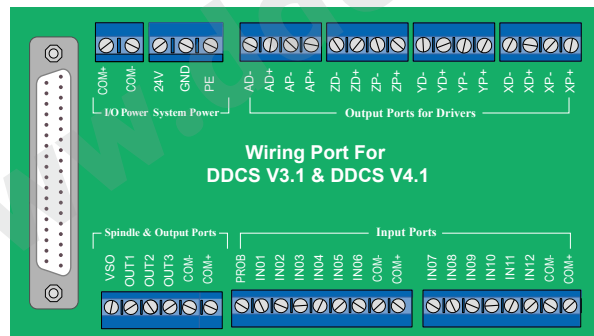
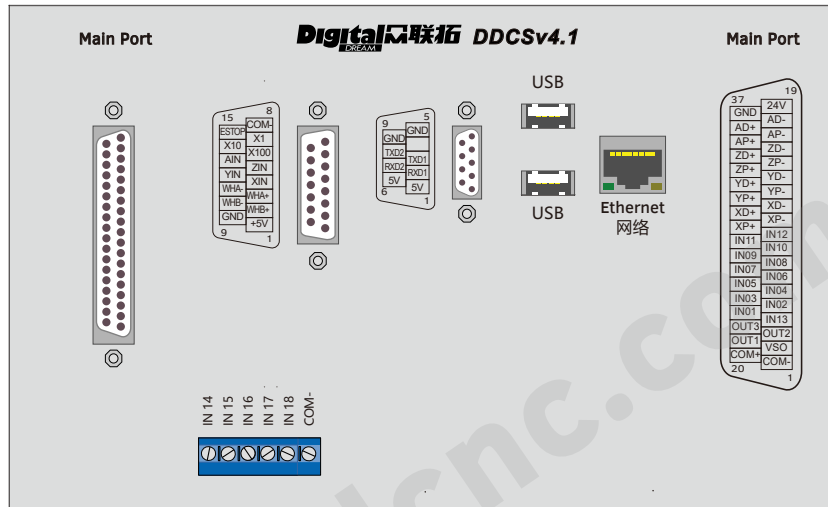

Figure 2-1 DDCS V4.1 communicate with Wiring board by DB37

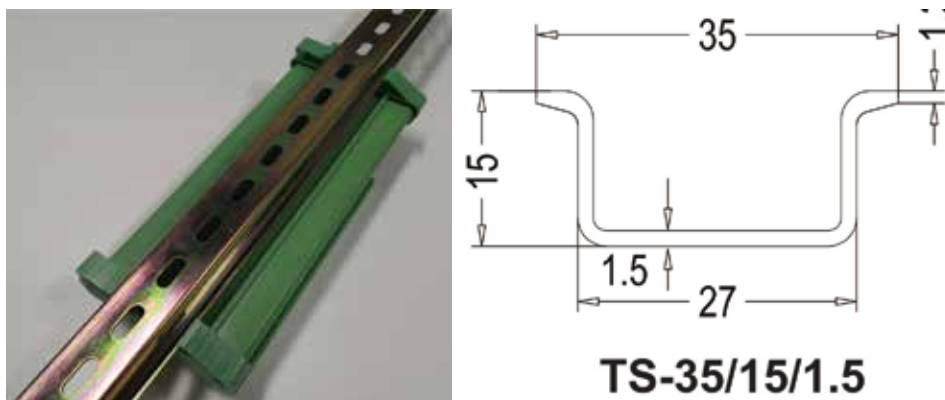

Figure 2-2 guide rail drawing, the unit is mm

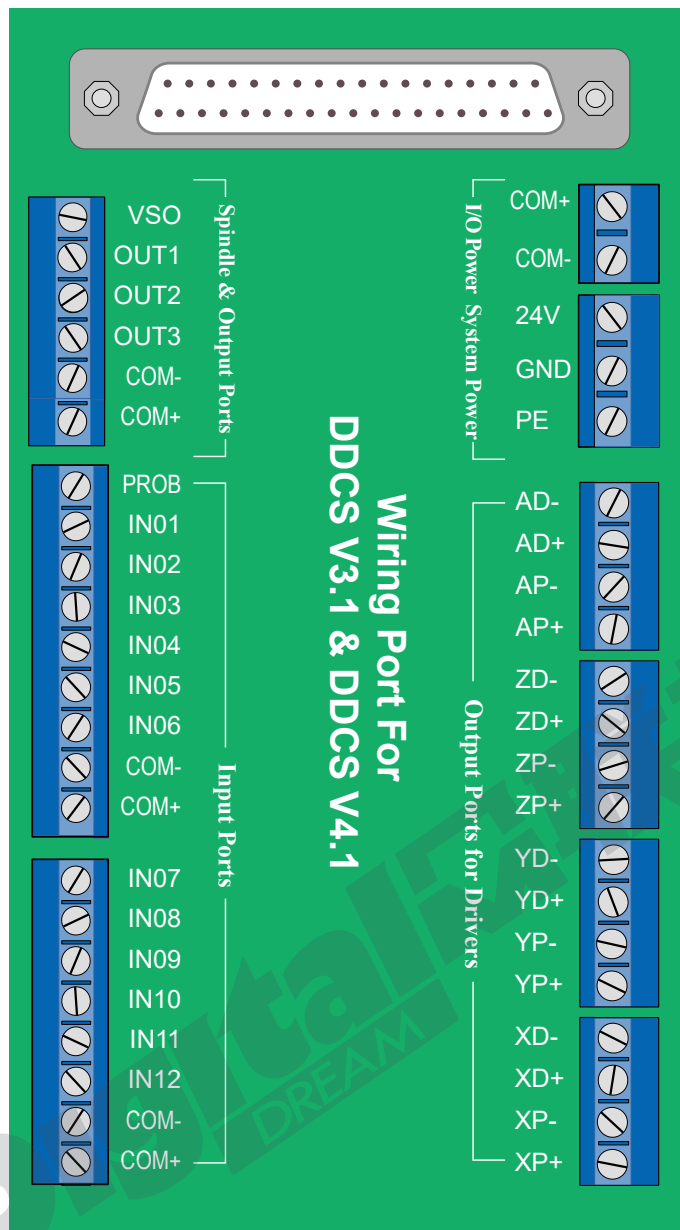

Figure 2-3 Wiring Board Drawing

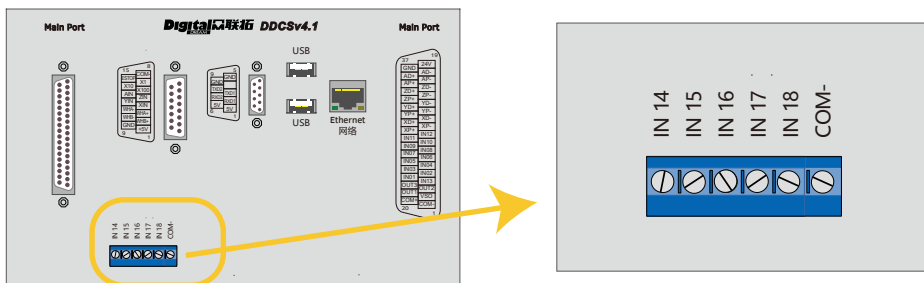

Figure 2-4 The Ports at the back of DDCCS V4.1 controller

All the input and output ports are fixed in DDCS V3.1. And the input and output port for DDCS V4.1, the users can configurate themselves. The users can go to the Parameter page and find "Output signal parameters" and "Input signal parameters" to configurate the ports number.

PIN No.	Mark on V3.1	Mark on V4.1	Kinds	Definition	Signal
20	COM+	COM+	Power Supply Input for IO ports	Positive Side of Power Supply for IO Port	24VDC 3A
1	COM-	COM-		Negative side of Power Supply for IO Port	
19	24V	24V	Power Supply Input for Controller System	Positive Side of Power Supply for Controller	24VDC 3A
37	GND	GND		Negative Side of Power Supply for Controller	
18	AD-	AD-	A axis signal output	A axis Direction Signal Negative Output	Cable-driven Output; Max. Interpolation Pulse Frequency 500Khz.
36	AD+	AD+		A axis Direction Signal Positive Output	
17	AP-	AP-		A axis Pulse Signal Negative Output	
35	AP+	AP+		A axis Pulse Signal Positive Output	
16	ZD-	ZD-	Z axis signal output	Z axis Direction Signal Negative Output	
34	ZD+	ZD+		Z axis Direction Signal Positive Output	
15	ZP-	ZP-		Z axis Pulse Signal Negative Output	
33	ZP+	ZP+		Z axis Pulse Signal Positive Output	
14	YD-	YD-	Y axis signal output	Y axis Direction Signal Negative Output	
32	YD+	YD+		Y axis Direction Signal Positive Output	
13	YP-	YP-		Y axis Pulse Signal Negative Output	
31	XP+	XP+		Y axis Pulse Signal Positive Output	
12	XD-	XD-	X axis signal output	X axis Direction Signal Negative Output	
30	XD+	XD+		X axis Direction Signal Positive Output	
11	XP-	XP-		X axis Pulse Signal Negative Output	
29	XP+	XP+		X axis Pulse Signal Positive Output	
2	VSO	VSO	Analog Output	Connect with Analog input port	0-10V Analog
21	M3	OUT1	In the Parameter Page can configurate the port numbers.	By Para #127~#130, can configurate the output port 0, 1, 2, 3 to: M3 port M4 port M8 port M10 port	The Max. capacity of the output ports is 30V, 500mA.
3	M8	OUT2			
22	M10	OUT3			
1	COM-	COM-	Spindle COMMON		
4	PROB	IN13	In the Parameter Page can configurate the port numbers.	By Para #136~#161, can configurate the 18 input ports to these options: X axis driver alarm port; Y axis driver alarm port; Z axis driver alarm port; A axis driver alarm port; X axis positive limit port; Y axis positive limit port; Z axis positive limit port; A axis positive limit port; X axis negative limit port; Y axis negative limit port; Z axis negative limit port; A axis negative limit port; X axis home port; Y axis home port; Z axis home port; A axis home port; Probe Port; External emergency stop port; Extended Function Key 1 Port; Extended Function Key 2 Port; Extended Function Key 3 Port; Extended Function Key 4 Port;	Support Mechanical, photoelectric and proximity switch, 24VDC; Type: NPN
23	LIMITX+	IN01			
5	LIMITX-	IN02			
24	HOMEX	IN03			
6	LIMITY+	IN04			
25	LIMITY-	IN05			
7	HOMEY	IN06			
26	LIMITZ+	IN07			
8	LIMITZ-	IN08			
27	HOMEZ	IN09			
9	LIMITA+	IN10			
28	LIMITA-	IN11			
10	HOMEA	IN12			
Input ports behind the controller		IN14			
		IN15			
		IN16			
		IN17			
		IN18			

## 2.2 DDCS V4.1 Power Supply Input

COM+ and COM- is the power input ports for Input/Output Port and MPG, 24V and GND is the power input ports for controller system. Please keep in mind, only when the two power supplies are connected correctly the controller can be work properly.

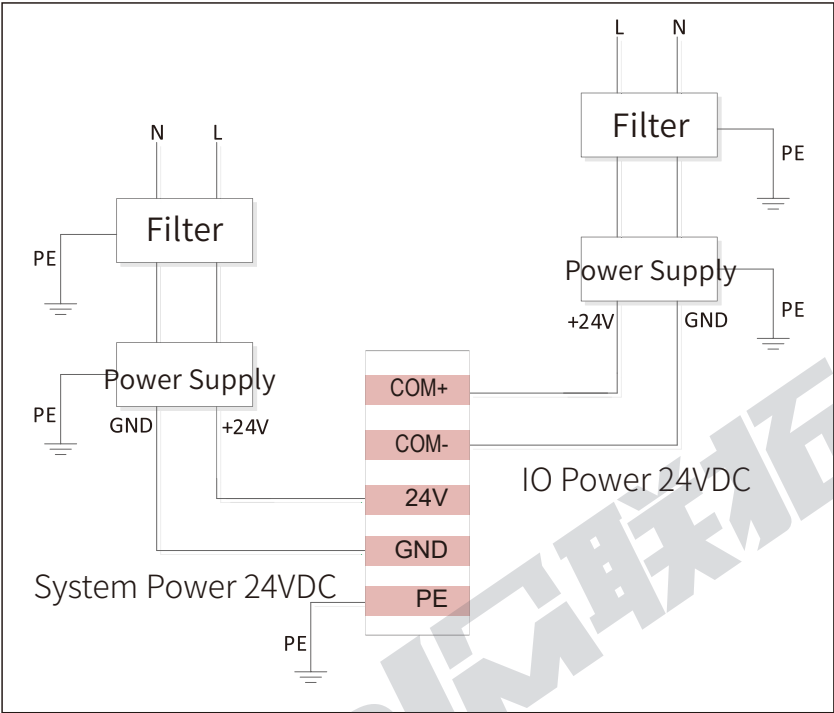

Figure 2-5 DDCS V4.1 Power Supply Wiring Methods

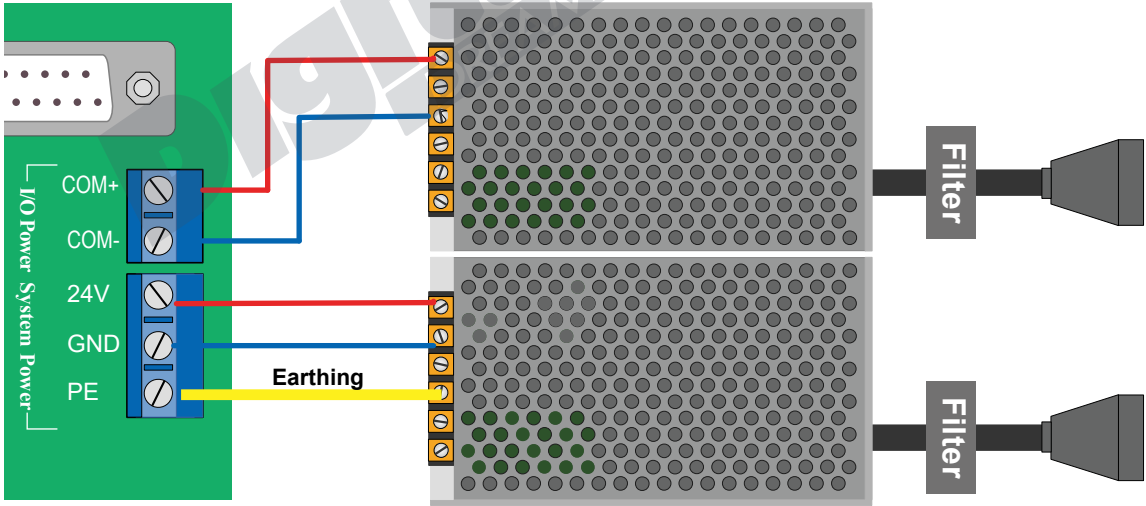

Figure 2-6 DDCS V4.1 Power Supply Wiring Methods

## 2.3 DDCS V4.1 Stepper/Servo Control Output

The stepper/servo control output, we cite differential Pulse and Direction output method. By the Para #012~015, the users can configure the drive mode for the 4 axis. There is 3 or 4 axis for optional.

Max. output frequency is 500Khz, please take attention to the max. pluse input frequency of the driver.

No support Common anode wiring or common cathode wiring methods.

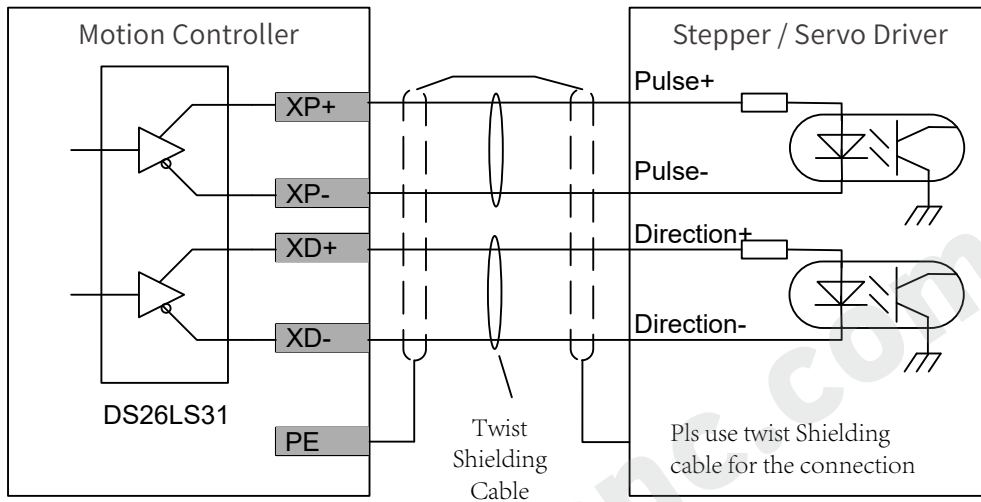

Figure 2-6 DDCS V4.1 Pluse and direction signal wiring methods

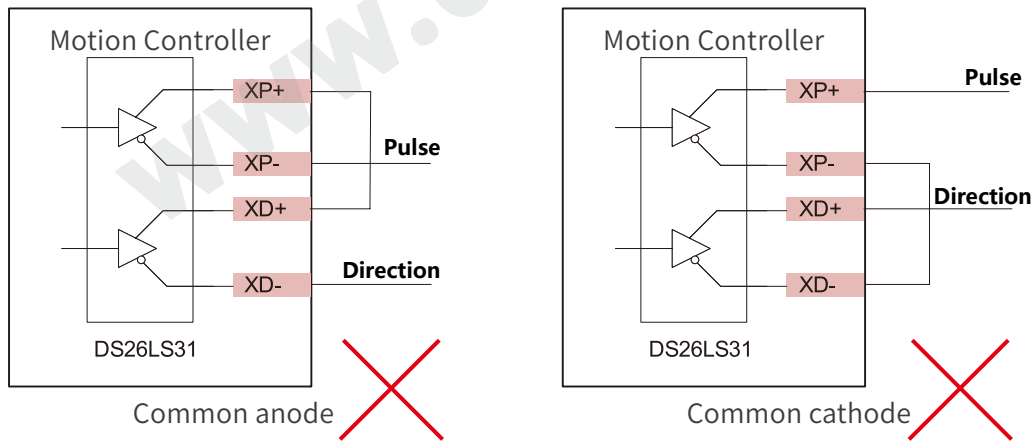

Figure 2-7 DDCS V4.1 No support Common anode or common cathode wiring methods

DDCS V4.1 added Driver Alarm input ports the users can configure the input port number and wire. For example: we already configure the Z axis driver alarm input port to Number 12.

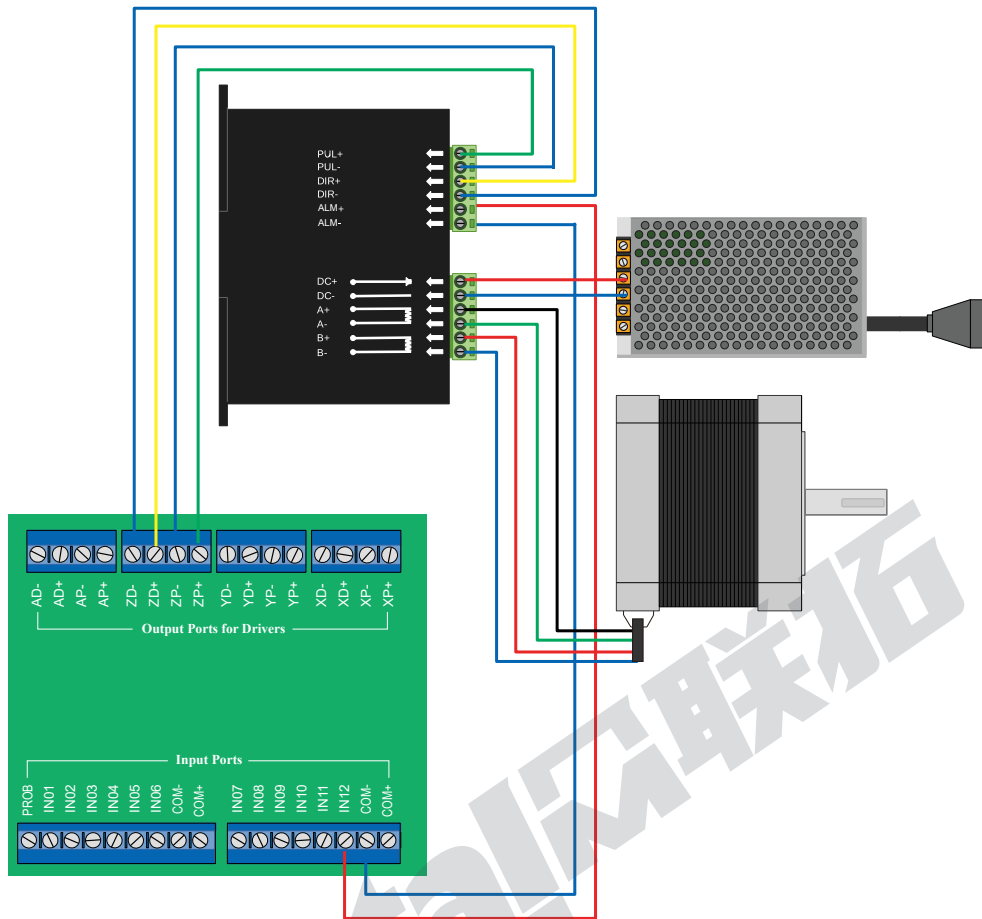

Figure 2-8 DDCS V4.1 Wiring example with stepper driver

There is motor parameters settings at the Parameter Page, the users can set the pulse equivalent ( $= \text{numerator} / \text{denominator}$ ), the driver mode, the slave or master axis and so on. We also explain the motor parameters in details in the Parameter Chapter.



## 2.4 DDCS V4.1 Spindle control outputs

DDCS V4.1 Support 2 kinds Spindle Mode: Analog Spindle / Servo Spindle (PUL+DIR). By Para #188 configurate the spindle as Analog or Servo Spindle, By Para #189 we select the servo spindle channel. Here we take the example of the analog spindle.

The spindle control output ports (OUT01-OUT03) offer connections for Start and Stop of the Spindle (M3/M5), Start/Stop of Cooling (M8/M9), Start/Stop of Lubrication (M10/M11). These three output terminals are signals open to ground. The highest electric current can be absorbed is 50mA. The speed controlling output terminal can output 0-10V. It can adjust the speed of the spindle motor by sending the voltage between 0 and 10V to the VFD according the the Spindle Speed Setting.

The following Figure 2-9 shows the wiring with Sunfar VFD:



Figure 2-9 DDCS and VFD wiring

Important:

- 1) The internal of the analog circuit is isolated from the IO power supply, and it is forbidden to short-circuit with IO power supply.
- 2) M3 is the spindle forward rotation output or start-stop output;
- 3) If the IO port is not powered, even if the inverter is connected correctly, it will not work; all IO ports must be powered to work properly.

When the spindle mode is Servo spindle, we need to choose the servo spindle channel, and wire with according driver ports to the spindle servo driver.

The general output circuits are all open-collector output structures as shown in the figure, which can be used to drive relay coils or optocoupler loads, the load capacity as shown in the figure; With the Inductive load we must install this kind Freewheeling diode.

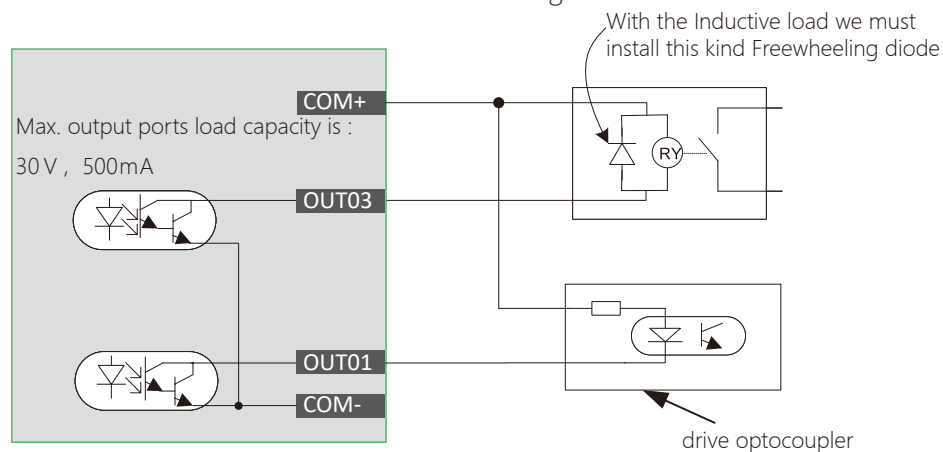

OUT0-OUT3 can be used as General common output ports, for example, can be used as the solid relay output ports, take the example of the figure below:

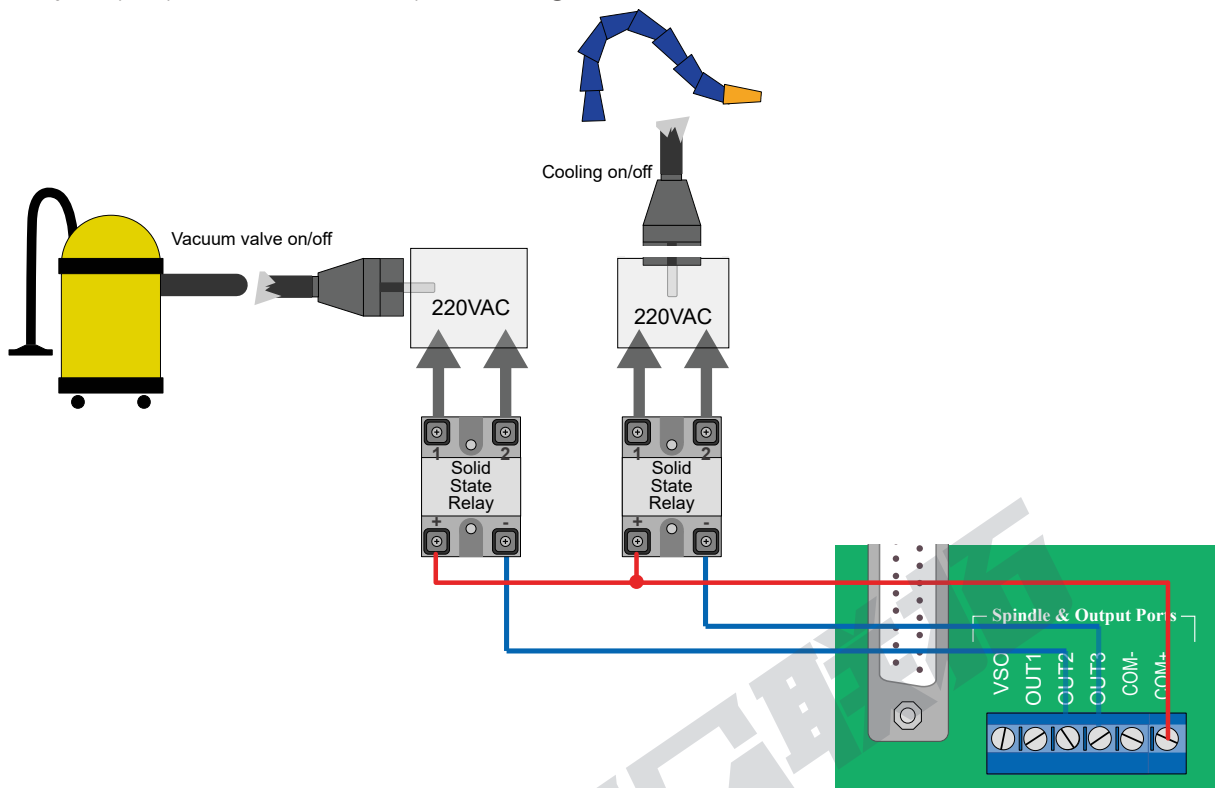

Figure 2-11 DDCS V4.1 output ports wiring with Relay

After Wiring, in the View page, we can check the wiring situation.

The related Parameter settings:

In the Parameter Page, the Sub-menu “Output signal Para”, we can configure the output number of M3/M5, M8/M9, M10/M11 and the electrical level.

In the Parameter Page, the Sub-menu “M output code Para”, we can set the delay time of M3/M4, M8/M9 and M10/M11.

## 2.5 Input Ports (IN01-IN18) Wiring

### 2.5.1 Limit, Home and Probe Input ports

The digital input circuit has the mechanical limit switch connection method and the open collector of the triode connection method. It supports the NPN type proximity limit switch.

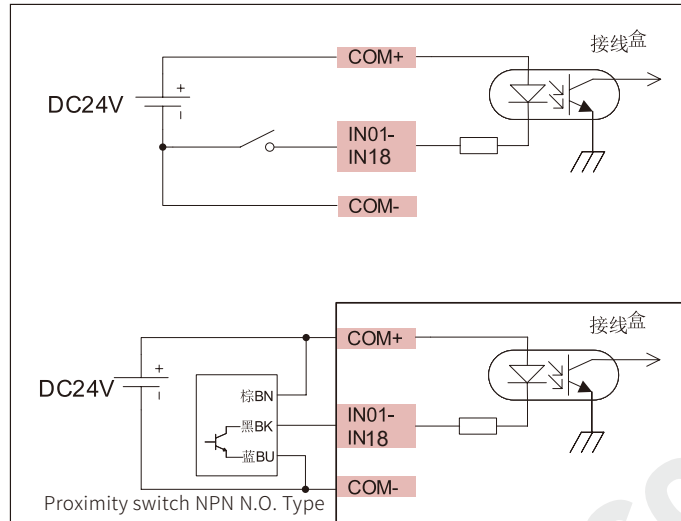

Figure 2-12 DDCS V4.1 Input ports wiring

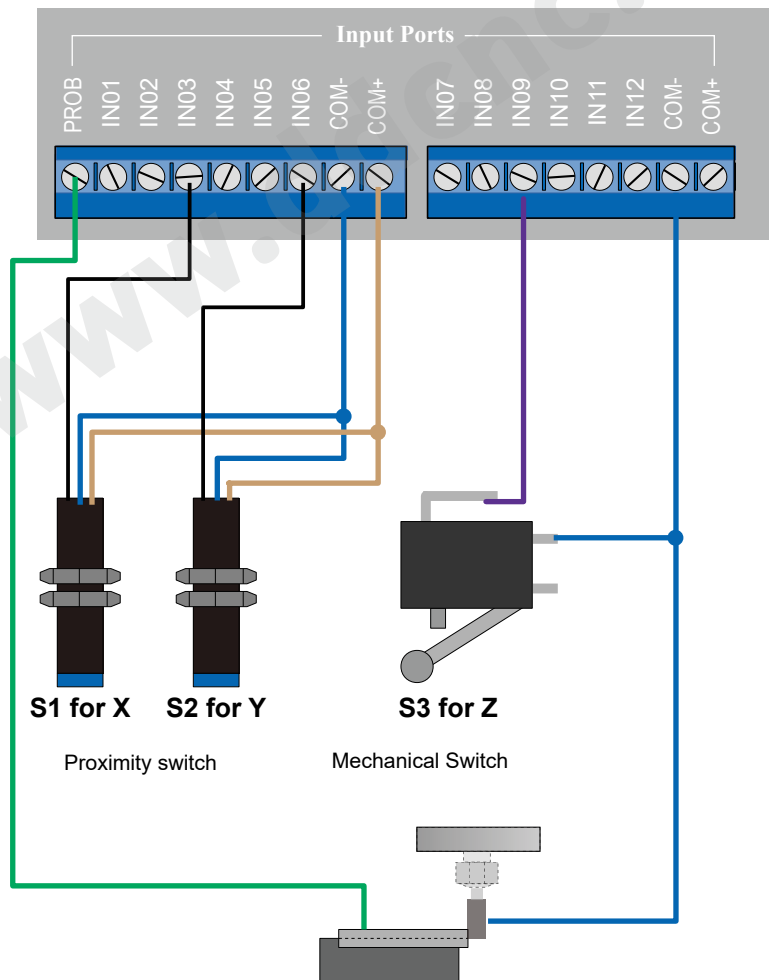

Figure 2-13 DDCS V4.1 wiring with limit switch and Probe

The example above, we already set at Submenu “Input signal Para” in the Parameters page as:  
 #151: X axis Home port is 03, then IN03 is the X axis home signal input port;  
 #152: Y axis Home port is 06, then IN06 is the Y axis home signal input port;  
 #153: Z axis Home port is 09, then IN09 is the Y axis home signal input port.  
 #156: Probe Port is 13, then IN13 is the probe signal input port.

Some users asked for the wiring methods for the probe with over-strock alarm, here we also set one sample for it.

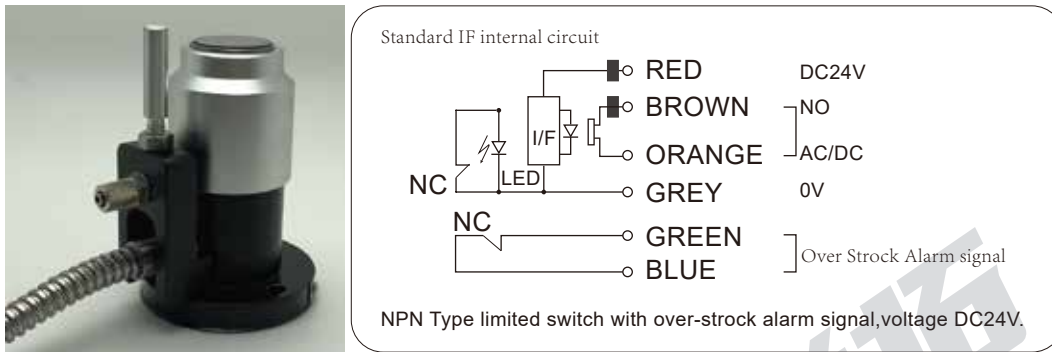

Figure 2-14 The Probe sensor with over-strock alarm signal

In the example, we configurate the IN13 as the Probe signal input port, and IN05 as the Z-- hard limit signal input port. Then wiring as below:

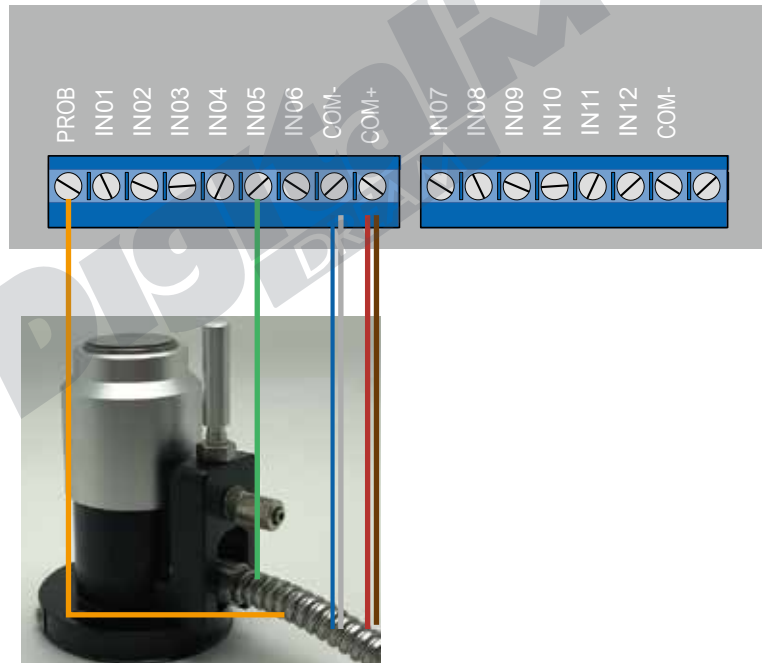

Figure 2-15 The Probe sensor with over-strock alarm signal

After completing the wiring, we can check the input ports status at the View page.

In the Sub-menu “Home Para” of the Paramters page, we can set the Home direction of each axis, the Home Speed, the back-distance and so on. And comparing with DDCS V3.1, the 4.1 version controller added the coordinate setting of the 4 references points.

The meaning of the related parameters, please refers to Parameter Chapter.

## 2.5.2 DDCS V4.1 Extended Function Inputs

#250~#253 Extended function key functions: 0 "Start"; 1 "Pause"; 2 "XY Zero"; 3 "Z Zero"; 4 "Home"; 5 "Floating probe"; 6 "Fixing probe"; 7 "Vertex probe"; 8 "X 1/2"; 9 "Y 1/2"; 10 "extkey1.nc"; 11 "Disable". The users can select the function as they want.

Take the example, how to define the “Start”, “Pause” and “E-stop” Extended function to the external keys.

By Submenu “Input signal Parameters” in the Parameters page:

Set “#157 External emergency stop port” to No. 16 input port; Set “#158 Extended Function Key 1 Port” to No. 14 input port; “#159 Extended Function Key 1 Port” to No. 15 input port.

Then set #250 to 0, then define input port 14 as “Start”; Set # 251 to 1, to define the input port 15 as the “Pause”.

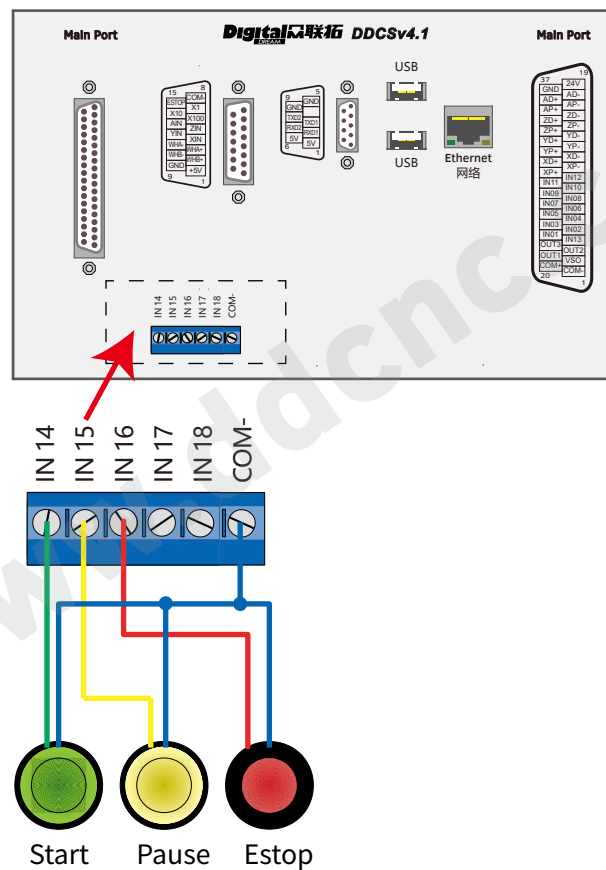

Figure 2-16 The example of external key wiring

The users also can edit Macro to self-define the external key function by “extkey.nc”.

The appendix also includes a list of macro definitions.

## 2.5.3 DDCS V4.1 MPG Wiring

MPG handwheel interface is showed as figure 2-15.

The users need to weld the MPG cables to the DB15 male parallel port, then plug into the controller DB15 female parallel port.

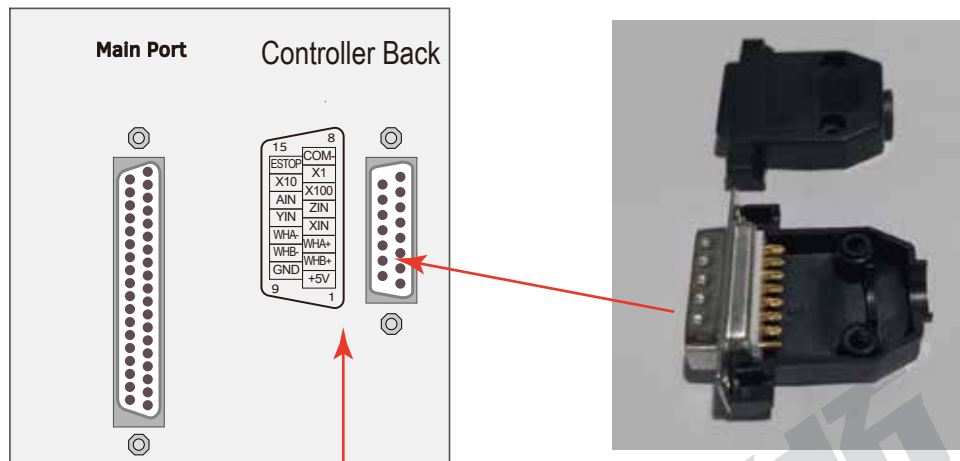

Figure 2-17 MPG Interface

It is 15 pins interface for the MPG plug, in the table below we define each pins.

Pin No.	Mark	Definition	Notes
1	+5V	Power Supply +	MPG Power supply input positive terminal
2	WHB+	Encoder B Phase +	MPG B differential input positive terminal
3	WHA+	Encoder A Phase +	MPG A phase differential input positive terminal
4	X-IN	Selection switch of X axis	Connect with GND,then X axis is selected
5	Z-IN	Selection switch of Z axis	Connect with GND,then Z axis is selected
6	X100	Selection switch 100 X	Connect with GND, then X100 ratio is selected
7	X1	Selection switch 1 X	Connect with GND, then X1 ratio is selected
8	COM-	Switch Signal common terminal	MPG power supply ground
9	GND	MPG Power supply Ground	MPG power supply ground
10	WHB-	Encoder B Phase -	MPG B differential input negative terminal
11	WHA-	Encoder A Phase -	MPG A differential input negative terminal
12	Y-IN	Selection Y Axis	Connect with GND,then Y axis is selected
13	A-IN	Selection A Axis	Connect with GND,then the 4th axis is selected
14	X10	Selection switch 10 X	Connect with GND, then X10 ratio is selected
15	ESTOP	ESTOP Input	Connect with GND,then Estop is active



MPG PIN No. and Mark		Pin definition	MPG Pin and Mark	MPG Output Cable Color
1	+5V	Power Supply +	5V	RED
2	WHB+	B Phase +	B+	PURPLE
3	WHA+	A Phase +	A+	GREEN
4	XIN	X Axis	X	YELLOW
5	ZIN	Z Axis	Z	BROWN
6	X100	X100 Ratio	X100	ORANGE
7	X1	X1 Ratio	X1	Grey
8	COM-	MPG common COM-	COM	ORANGE/BLACK
9	GND	Ground	GND	BLACK
10	WHB-	B Phase -	B-	PURPLE/BLACK
11	WHA-	A Phase -	A-	WHITE
12	YIN	Y Axis	Y	YELLOW/BLACK
13	AIN	A Axis	A	BROWN/BLACK
14	X10	X10 Ratio	X10	GREY/BLACK
15	ESTOP	ESTOP	EP	BLUE

Note: If you want to use the single-terminal MPG (there is no A-B-MPG), please refer to the table below for reference. As for the unlisted MPG, please take the differential MPG wiring mode.

DDCS Wiring Pin Mark	MPG Pin Mark and Color	
WHA+	A+	Green
WHA-	0V	Black
WHB+	B+	White
WHB-	0V	Black

Important:

- 1) All the input signal COMMON terminal is COM-, not GND; Never short connect GND and COM-;
- 2) The MPG needs the power from the IO power port (COM+ / COM-), or the MPG cannot work;
- 3) When the MPG is wired up, the control system can detect it and shift to MPG mode automatically;
- 4) Via View Page, we can check the MPG signal status;

5) In the Parameter Page -- Param Type -- MPG Parameters, we can set the speed and acceleration of every axis in MPG mode, and also we can set the MPG Precision, motion direction and so on; One point is important, When open the MPG control Mode, controller will execute each signal the MPG generates, even you already stopped turning the wheel; When the MPG control mode is closed, if you stopped turning the wheel, controller also stopped.

## 2.5.4 View Page

In the view page, we can check the input and output ports status.

In the main page, press the View key two times and enter into the view page.

CONT	READY	Audisk-sda1/ball1.nc				+00:00:00	Guest
X10.000	LIMIT++ 05 HI	LIMIT-- 00 LOW	HOME 03 HI	ALARM 00 LOW	FRO:	100%	
Y11.000	02 LOW	06 LOW	04 HI	05 LOW	SRO:	100%	
Z10.000	00 LOW	00 LOW	09 HI	00 LOW	JSR:	100%	
A0.000	00 LOW	00 LOW	12 HI	00 LOW	F	0 3000	
Probe ESTOP Ext.IO 13 HI 00 LOW 6 Ext-key1 Ext-key2 Ext-key3 Ext-key4 00 LOW 00 LOW 00 LOW 00 LOW					S	0 12000	
X-sel Y-sel Z-sel A-sel MPG HI HI 7 HI HI 0x3 X1 X10 X100 EStop HI HI HI HI					G54 H00 M5 M9 M11		
Software Ver: 2022-05-29-001-NOR Synchronize network time... ID:04-01050001-365196531ea215b6							
Start	Pause	Reset	View	MpgGuide	Spindle	File...	00:00:37 1970-01-01

Figure 2-18 View Page

1: It's the Mechanical Coordinates.

2: The numbers are the limit++ signal input port numbers for the each axis; Red Square shows the current signal is Invalid, and Green Square shows the current signal Effective; HI means High level and LOW means low level.

3: The numbers are the limit-- signal input port numbers for the each axis; Red Square shows the current signal is Invalid, and Green Square shows the current signal Effective; HI means High level and LOW means low level.

4: The numbers are the HOME signal input port numbers for the each axis; Red Square shows the current signal is Invalid, and Green Square shows the current signal Effective; HI means High level and LOW means low level.

5: The numbers are the ALARM signal input port numbers for the each axis; Red Square shows the current signal is Invalid, and Green Square shows the current signal Effective; HI means High level and LOW means low level.

6: The column includes the Probe signal, E-stop Signal and 4 extended function key input signals; Red Square shows the current signal is Invalid, and Green Square shows the current signal Effective; HI means High level and LOW means low level.

7: It's for the MPG input ports. X-sel/Y-sel/Z-sel/A-sel show the input signal for XYZA axis Respectively; X1/X10/X100 show the input signal for the Ratio of the XYZ axis; Red Square shows the current signal is Invalid, and Green Square shows the current signal Effective; HI means High level and LOW means low level.

In Parameter Page -- Param type -- input signal parameters, we can configurate the input ports numbers and the Active electric level.



# 3 Software and operation

## 3.1 DDCS V4.1 Key definition

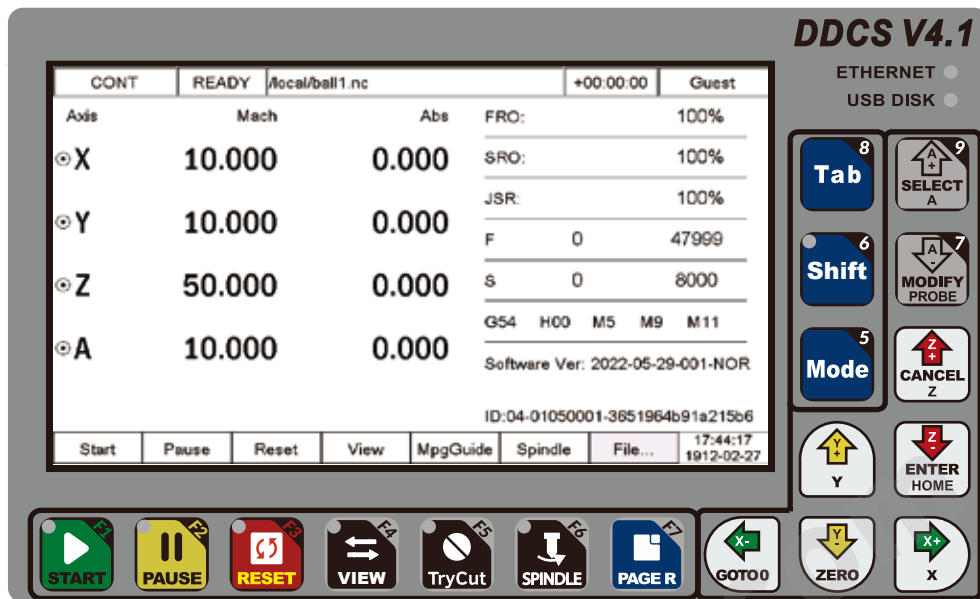



















Figure 3-1 DDCS-V4.1 Controller Panel

Key	Definition	Description
ETHERNET ●	The indicator for Ethernet	When the Ethernet communication is hooked up the LED indicator lights up.
USB DISK ●	The indicator for USB port	When controller detected the USB stick the red LED indicator lights up.
	1: Start operation 2: F1 function key	1: After loading the G code file, please press this key to start the operation. In case of Pause Status, press this key to continue the processing operation. 2: In different page, the F1 function key can be given with different function.
	1: Pause operation 2: F2 function key	1: Press this key to Pause the operation. 2: In different page, the F2 function key can be given with different function.
	1: Reset and E-STOP 2: Number key 0 3: F3 function key	1: If Reset is blinking, press this key to activate the controller. Press this key to stop processing urgently. 2: When the number function is enabled, this key can be used as number key "0" 3: In different page, the F3 function key can be given with different function.
	1: Main Page/Simulation/View 2: Number key 1 3: F4 function key	1: When in Main page, press the key one time go to Simulation page, and press it again, go to View Page. 2: When the number function is enabled, this key can be used as number key "1" 3: In different page, the F4 function key can be given with different function.
	1: Try Cut (handwheel guide) 2: Number key 2 3: F5 function key	1: Press this key to enable and disable the Try cut (Handwheel guiding) status. 2: When the number function is enabled, this key can be used as number key "2" 3: In different page, the F5 function key can be given with different function.
	1: Spindle ON/OFF 2: Number key 3 3: F6 function key	1: Press this key to manually switch the spindle on or off. Can not be used if Reset is blinking and while processing an operation (Busy). 2: When the number function is enabled, this key can be used as number key "3" 3: In different page, the F6 function key can be given with different function.
	1: Main Page/File Page/Para Page 2: Number key 4 3: F7 function key	1: When in Main page, press the key one time go to the File page, and press it again, go to Parameters Page. 2: When the number function is enabled, this key can be used as number key "4" 3: In different page, the F7 function key can be given with different function.
	1: FRO/SRO/SJR/F/S/G 2: Number key 8	1: This switch will highlight the processing parameters FRO/ SRO/S-JR/F/S/G54-59-MACH/M3-M11; While in BUSY it can activate FRO and SRO. 2: When the number function is enabled, this key can be used as number key "8"

Key	Definition	Description
	1: 2nd Mode 2: Menu Mode 3: Number Key 6	1. When #313 Param is Menu: A) goto zero, B) zero, C) home, D) Probe, E) Advanced Machining, F) Bias management, G) Breakpoint, H) Coordinate origin, I) Center, J) Silumation 2. When #313 Param is 2nd function: With the according keys active Goto Zero/Zero/Home/Probe ect. functions 3. When the number function is enabled, this key can be used as number key "6".
	1: Mode switch 2: Number Key 5	1. In the main page, when in the ready status, press this key to switch the manual mode of each axis. There are three manual modes, namely "step", "continuous" and "MPG" mode; when the controller detects MPG is hooked up, the system will automatically switch to the MPG mode. At this time, pressing this key will switch between the three modes; when the system does not detect the MPG, pressing this key will only Rotate between continuous and step; in addition, when switching to step, the system will pop up a dialog box of step distance. 2. When the number function is enabled, this key can be used as number key "5".
	1: X axis moves left 2: Cursor moves left 3: Goto Zero function	1. In "CONT Mode", the X axis will Continuously move negative after pressing this key. In "STEP Mode" X will move negative in steps. 2. When in "Line/Value Editing" or default F/S value modification, this key moves the cursor left. 3. When in "2nd Function", this key has the goto Zero function.
	1: X axis moves right 2: Cursor moves right 3: X axis select	1. In "CONT Mode", the X axis will Continuously move positive after pressing this key. In "STEP Mode" X will move positive in steps. 2. When in "Line/Value Editing" or default F/S value modification, this key moves the cursor right. 3. X axis selection
	1: Y axis moves forward 2: Para value increases 3: Y axis select	1. In "CONT Mode", the Y axis will continuously move positive after pressing this key. In "STEP Mode" Y will move positive in steps. 2. When in "Line/value Editing" or default F/S value modification, this key increases the value. 3. Y axis selection.
	1: Y axis move backward 2: Para value decreases 3: Current coordinate 0	1. In "CONT Mode", the Y axis will continuously move negative after pressing this key. In "STEP Mode" Y will move negative in steps. 2. When in "Line/value Editing" or default F/S value modification, this key decreases the value. 3. When you start the 2nd function, this key has the Y coordinate function.
	1: Z axis Lift up 2: Z axis select 3: Cancel	1. In "CONT Mode", the Z axis will continuously move positive after pressing this key. In "STEP Mode" Z will move positive in steps. 2. When in "home/zero-clearing/ gotoz", this key opens Z axis coordinate edit window. 3. This key is also CANCEL key.
	1: Z axis down 2: Home 3: Enter/select	1. In "CONT Mode", the Z axis will continuously move negative after pressing this key. 2. In "STEP Mode" Z will move negative in steps. 3. This key serves as the ENTER key and also is the HOME key.
	1: A axis rotates CW 2: A axis select 3: Value increases 4: F/S elect/cancel 5: Number Key 9	1. In "CONT Mode", the A axis will continuously move positive after pressing this key. In "STEP Mode" A will move positive in steps. 2. When in "home/zero-clearing/ gotoz", this key opens the A axis coordinate edit window. 3. When in FRO/ SRO/ SJR this key increases the parameter value. 4. When in F or S, this key switches between default value or G code value. 5. When the number function is enabled, this key can be used as number key "9".
	1: A axis rotates CCW 2: Probe function 3: Value decreases 4: F/S default modify 5: Number Key 7	1. In "CONT Mode", the A axis will continuously move negative after pressing this key. In "STEP Mode" A will move negative in steps. 2. When in 2nd function, this key activates the PROBE. 3. When in FRO/ SRO/ SJR this key decreases the parameter value. 4. When in F or S, this key will open the Editing Window. 5. When the number function is enabled, this key can be used as number key "7".

"Shift" key can be defined as "Menu" or "2nd function" by parameter #313, among which the menu function is the newly added content of DDCS V4.1, and the 2nd function is roughly the same as DDCS V3.1, please pay attention to the differences.

It should be noted that since DDCS V4.1 has correspondingly added many functions, only 17 keys is really not enough, so we defined the "Start" and other keys totally 7 keys to be composite keys, and at the same time, namely F1-F7, which can be Perform corresponding operations according to the on-screen prompts.

At the same time, when the number input function is activated, such as inputting parameter numbers and passwords, some keys are also activated as number keys, see the example below:

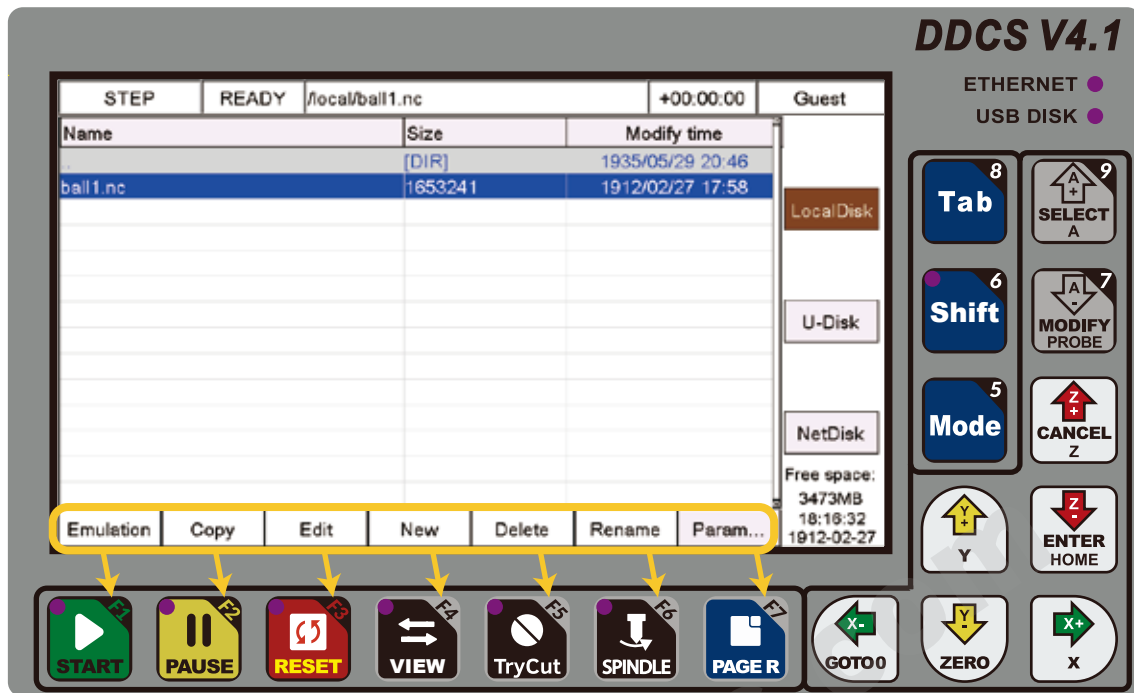

Figure 3-2 F1-F7 Function Key

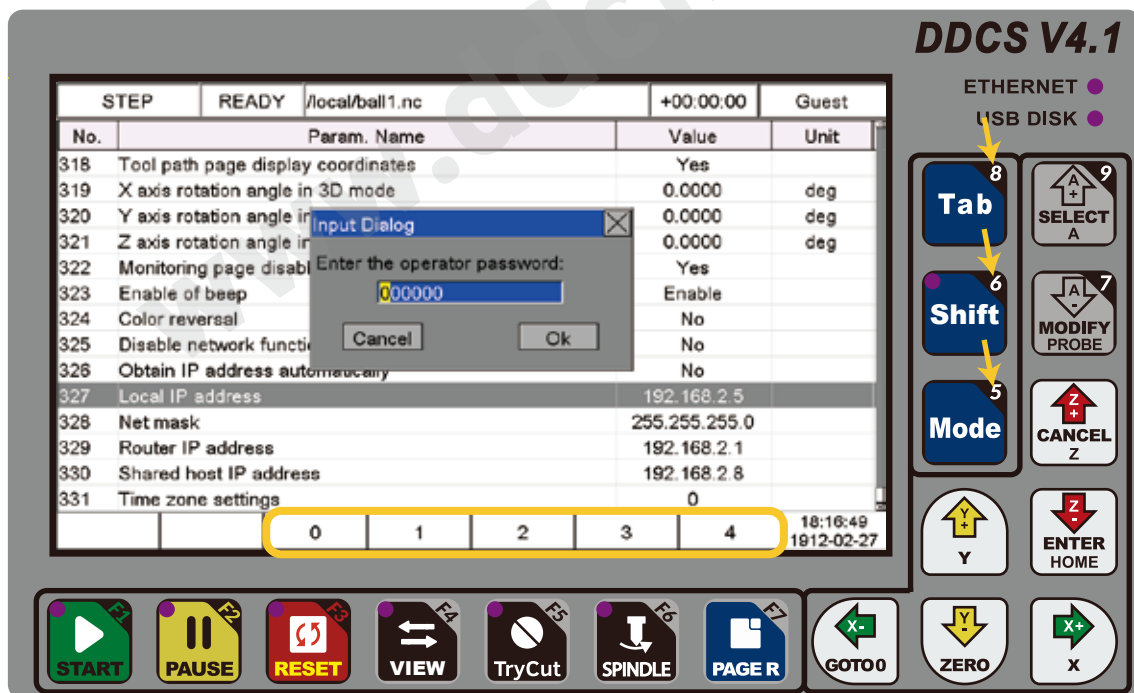

Figure 3-3 Number Key is active

## 3.2 DDCS V4.1 Interface description

The software interface contains 3 pages. Main page, File page and Parameters page. By pressing File key, the 3 pages switched sequentially.

### 3.2.1 Main Page

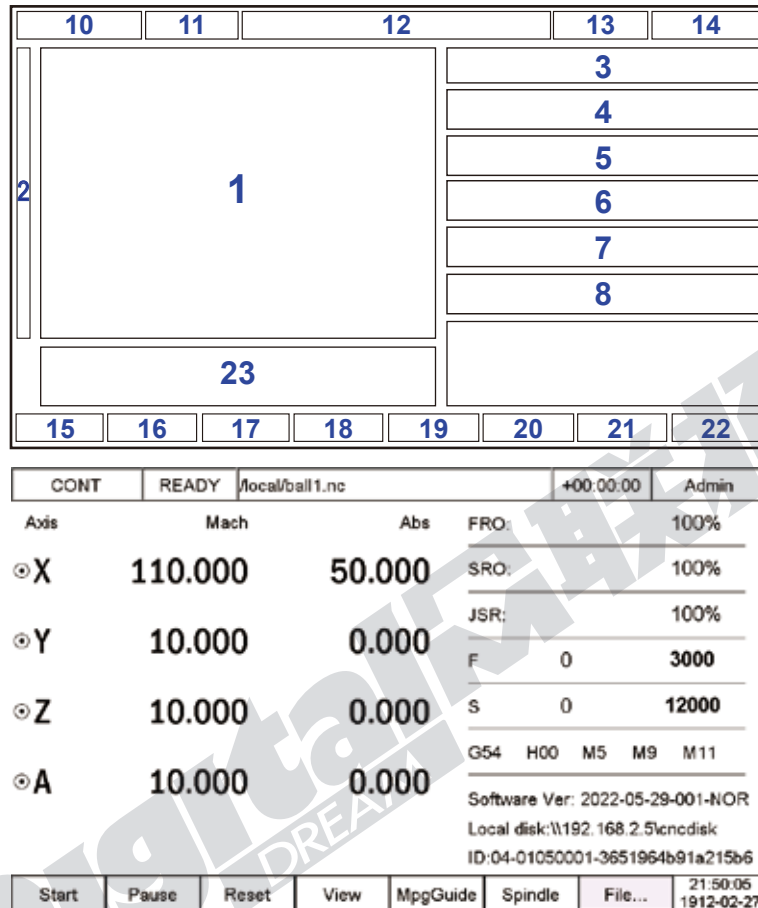

Figure 3-4 Main Page

The Figure 3-4 shows the Main page of the DDCS. It is divided into status column, coordinate display column, basic parameter column, and notification column. In total, it is divided into 23 sections in detail. Here the detailed description of the 23 sections :

#### 1、The mechanical coordinate and current workpeice coordiante for XYZA axis

This column shows the mechanical coordinate value of each axis, the display range is -99999.999~+99999.999, the precision is 0.001; Please note the current unit is in metric or imperial. The default is metric, we can edit it in Parameter #001.

In the MPG mode, we can check the symbol of “ ” to check which axis is active by MPG.

**2、Home symbol:** The Home symbol is “”, Non-Home symbol is “”, by the symbol the users can check if the system is homed or not.

### 3、FRO

FRO controls the feedrate override. Press Tab key till FRO is highlighted by Flashing red and blue color. When the value is less than 100% the color becomes to Blue, and bigger than 100% the color becomes to Red. By A+/A- keys to adjust the value in 5% increments, the range is 0% - 300%.

When in Auto mode, the FRO also can be edited in time.

### 4、SRO

SRO controls the spindle rate override. Press Tab key till SRO is highlighted by Flashing red and blue color. When the value is less than 100% the color becomes to Blue, and bigger than 100% the color becomes to Red. By A+/A- keys to adjust the value in 5% increments, the range is 0% - 150%.

When in Auto mode, the SRO also can be edited in time.

### 5、JSR

SJR controls the jogging of the machine. Press Tab Key until JSR is highlighted by Flashing red and blue color. When the value is less than 100% the color becomes to Blue, and bigger than 100% the color becomes to Red. The range is 0% - 150%.

Firstly to confirm which mode the controller is in, Cont or Step or MPG.

In the mode of CONT, by A+/A- key we can adjust the value in 5% increments;

IN the mode of Step, by A- key to pop up the windows of Step distance. Now the number key is active, we can use the number key to input the distance value. This value can replace the value of #98"Jog-1 moving distance"

There are 3 Jog distaces set by the parameter "#98 Jog-1 moving distance", "#99 Jog-2 moving distance" and "#100 Jog-3 moving distance", by A+ key the users can swith the 3 distances sequentially.

### 6、F Feed speed

Press Tab key till F is highlighted by Flashing red and blue color. The value in middle shows the real time Feeding speed, the value in right shows the default F speed, we can edit the default F speed by A- key. Then the number key is active, we can use the number key to input the speed value. This value can replace the value of #102 default operation speed".

When execute a program, the actual F is the default F speed or the F from G code program, that can be decied by the parameter "#101 Speed Selection".

### 7、S Spindle speed

Press Tab key till S is highlighted by Flashing red and blue color. The value in middle shows the real time spindle speed, the value in right shows the default spindle speed, we can edit the default spindle speed by A- key. Then the number key is active, we can use the number key to input the speed value. This default spindle speed value can replace the value of #191 Default spindle speed".

When execute a program, the actual F is the default spindle speed or the S from G code program, that can be decied by the parameter "#190 Spindle speed selection".

## 8、G54 H00 M5 M9 M11

G54: Press Tab key till G54 is highlighted by Flashing red and blue color. Press A- key to call up g54~g59 coordinate system management. You can select the coordinate by Y+ and Y- keys and press Enter to confirm.

H00: Press Tab key till H00 is highlighted by Flashing red and blue color. Press the A- key to call up the Tool management window. You can select the tool through the Y+/Y- key and X+/X- key. Short press the Enter key to activate the number keys, then you can enter the values. Long press the Enter key to confirm the value and exit the tool management window.

M3/M5: Press A- key to switch between the start and stop the spindle.

M8/M9: Press A- key to switch between the start and stop the coolant.

M10/M11 : Press A- key to switch between the start and stop the Lubricant.

## 9、Display software version No., Local disk path and controller unique tracking number

About the Local disk path, 192.168.2.5 shows the the controller P address.

About the ID, 03 means 3 axis and 04 means 4 axis.

**Software Ver: 2022-05-29-001-NOR**

**Local disk: \\192.168.2.5\cncdisk**

**ID:04-01050001-3651964b91a215b6**

## 10、Feed status

This window shows the feed status of Jogging and File Processing.

AUTO: displayed while processing and executing the G code file.

CONT: indicates Jog CONTINUOUS. You can Jog manually with the “-” or “+” keys of X Y Z and A. A short click will move the axis in the defined step, a long click will move the axis till you let go.

Step: Jogging in Step Mode.

MPG: MPG mode. MPG takes over Jog control.

Note: When in Try cut is active, the background of this column is blue, and current mode isn't changed.

## 11、Operating Status

This column shows the operating state. The status and implications can be displayed as follows:

Busy: Operation is running.

Reset: Reset flashing = controller not active. To activate the controller click Reset.

READY: Ready state. Controller is ready and all operations can be performed.

Bias: The controller in Bias mode.

And when the the background of this column is blue, means Trycut is active.

## **12、 Processing file**

This column shows the name of the processing files. In the formal situation, it only shows the filename and file path. Under the situation of CONT adjust, it will also show the content of the file. When system cannot find this file, the background turns to red color.

## **13、 Work Time**

The working time for the current G-code file. When restart the program, it will start to count.

## **14、 User's Rights**

This controller Support 4 kinds operation rights: visitor, operator, admin, super admin. This column shows the current rights.

## **15、 Start and F1 keys**

This is a composite key. In the main page, it is a Start function key; In the file page It is a Simulation function key; In the parameters Page it is a Parameter Type function key.

And the system will give different functions to the control system under different states. Please refer to the system prompt.

## **16、 Pause and F2 Key**

This is a composite key. In the main page, it is a Pause function key; In the file page It is a Copy function key; In the parameters Page it is a Search function key. And the system will give different functions to F2 under different states. Please refer to the system prompt.

## **17、 Reset and F3 Key**

This is a composite key. In the main page, it is a Reset function key; In the file page It is a Edit function key; In the parameters Page it is a Visible function key. And the system will give different functions to F3 under different states. Please refer to the system prompt.

## **18、 View and F4 Key**

This is a composite key. In the main page, it is a View function key; In the file page It is a New function key; In the parameters Page it is a Backup function key.

And the system will give different functions to F4 under different states. Please refer to the system prompt.

When number keys is active, it can be used as 1 number..



## **19、 Try Cut and F5 Key**

This is a composite key. In the main page, it is a Try cut function key; In the file page It is a Delete function key; In the parameters Page it is a Backup function key.

And the system will give different functions to F5 under different states. Please refer to the system prompt.

When number keys is active, it can be used as 2 number.

## **20、 Spindle ON/OFF and F6 Key**

This is a composite key. In the main page, it is a Spindle ON/OFF function key; In the file page It is a Rename function key; In the parameters Page it is a Exit function key.

And the system will give different functions to F6 under different states. Please refer system prompt.

When number keys is active, it can be used as 3 number.

## **21、 File and F7 key**

This is a composite key. In the main page, By pressing it can switch to File page and parameters page.

When number keys is active, it can be used as 4 number.

## **22、 Date and Time**

## **23、 Status prompt bar**

When controller is running a program, the code of this line will be displayed here in real time; The point is that DDCS v4.1 has added a parsing error prompt. DDCS v3.1 does not have this function. If there is a parsing error, it will be stopped directly. If there is an error in DDCS v4.1, there will be a red letter warning on a yellow background in the prompt column. The user can find out the cause of the error according to the prompt.



### 3.2.2 FRO

FRO controls the Feed Rate Override. Press Tab key till FRO is highlighted by Flashing red and blue color. When the value is less than 100% the color becomes to Blue, and bigger than 100% the color becomes to Red. By A+/A- keys to adjust the value in 5% increments, the range is 0% - 300%. When in Auto mode, the FRO also can be edited in time.

$$\text{Current Feeding Speed } F\# = \text{Fixed Feeding Speed } F * \text{FRO}$$

### 3.2.3 SRO

SRO controls the spindle rate override. Press Tab key till SRO is highlighted by Flashing red and blue color. When the value is less than 100% the color becomes to Blue, and bigger than 100% the color becomes to Red. By A+/A- keys to adjust the value in 5% increments, the range is 0% - 150%. When in Auto mode, the SRO also can be edited in time.

$$\text{Current Spindle Speed } S\# = \text{Fixed Spindle Speed } F * \text{SRO}$$

### 3.2.4 JSR

Firstly to confirm which mode the controller is in, Cont or Step or MPG.

When in Cont Mode , SJR controls the jogging of the machine. Press Tab Key until JSR is highlighted by Flashing red and blue color. When the value is less than 100% the color becomes to Blue, and bigger than 100% the color becomes to Red. The range is 0% - 150%.

$$\text{Current Jogging Speed } FS\# = \text{Fixed Manual Speed } FS * \text{JSR}$$

In the mode of STEP, by A- key to pop up the windows of Step distance. Now the number key is active, we can use the number key to input the distance value.

The Step distances also can be set by “098~#100 Jog 1-3 moving distance”, the default Step distance is “#098 Jog-1 moving distance”, . When press the A+ key, system will display “#098~#100” the 3 values in turn. And if Press A- key, system also pop up window for the step distance editing. New step distance will replace the value of “#098~#100”.

寸动	设备忙	local/ball1.nc	+00:00:00	超级管理员
轴	机械坐标	工件坐标	进给修调:	100%
⊙X	10.000	0.000	主轴修调:	100%
⊙Y	10.000			0.100
⊙Z	49.999			0 99999
⊙A	10.001	0.001		0 15000
G54 H00 M5 M9 M11				
软件版本号: 2022-04-11-001-NOR				
ID:04-01050001-3651964b91a215b6				
		0	1	2
				3
				4
				18:08:51
				1912-02-27

Figure 3-5 Wirte in the step distance

### 3.2.5 F Feeding speed

F Feeding speed controls the default feeding speed of the control system. Press Tab key till F is highlighted by Flashing red and blue color, it is editable. Now Press A- to modify the value. By X+/X- to move the cursor, by Y+/Y- to increase or decrease the current position number, also you can use the number key to input the number directly.

CONT	READY	/local/ball1.nc	+00:00:00	Guest
Axis	Mach	Abs	FRO:	100%
⊙X	10.000	0.000	SRO:	100%
⊙Y	10.000	0.000	JSR:	100%
⊙Z	10.000	0.000	S	0 8000
⊙A	10.000	0.000	G54 H00 M5 M9 M11	
Software Ver: 2022-05-29-001-NOR				
Network not connected				
ID:04-01050001-3651964b91a215b6				
	0	1	2	3 4 17:45:04 1912-02-27

Figure 3-6 Write in the F value

As we set the Feeding speed number, and press A+, the current number becomes to a thicker font, it means the default F speed number is the current machining Feeding speed which is not from F value from G code file. Press A+ again, the number becomes to a normal font, then cancel it as the default Feeding speed, system will cite the feeding speed from the G code file.

CONT	READY	/local/ball1.nc	+00:00:00	Guest
Axis	Mach	Abs	FRO:	100%
⊙X	10.000	0.000	SRO:	100%
⊙Y	10.000	0.000	JSR:	100%
⊙Z	10.000	0.000	S	0 8000
⊙A	10.000	0.000	G54 H00 M5 M9 M11	
Software Ver: 2022-05-29-001-NOR				
Local disk:\192.168.2.5\ncdisk				
ID:04-01050001-3651964b91a215b6				
Start	Pause	Reset	View	MpgGuide Spindle File... 17:44:48 1912-02-27

Figure 3-7 the default F is system Feeding speed

CONT	READY	/local/ball1.nc	+00:00:00	Guest
Axis	Mach	Abs	FRO:	100%
⊙X	10.000	0.000	SRO:	100%
⊙Y	10.000	0.000	JSR:	100%
⊙Z	10.000	0.000	S	0 8000
⊙A	10.000	0.000	G54 H00 M5 M9 M11	
Software Ver: 2022-05-29-001-NOR				
Network not connected				
ID:04-01050001-3651964b91a215b6				
Start	Pause	Reset	View	MpgGuide Spindle File... 17:44:57 1912-02-27

Figure 3-8 the F from G code is system Feeding speed

### 3.2.6 S Spindle speed

S spindle speed controls the default spindle speed of the control system. Press Tab key till S is highlighted by Flashing red and blue color, it is editable. Now Press A- to modify the value. Press A+ to modify the value. By X+/X- to move the cursor, by Y+/Y- to increase or decrease the current position number, also you can use the number key to input the number directly.

CONT	READY	/local/ball1.nc	+00:00:00	Guest
Axis	Mach	Abs	FRO:	100%
⊙X	10.000	0.000	SRO:	100%
⊙Y	10.000	0.000	JSR:	100%
⊙Z	10.000	0.000	F	0 47999
⊙A	10.000	0.000	S	0 08000
G54 H00 M5 M9 M11				
Software Ver: 2022-05-29-001-NOR				
Network not connected				
ID:04-01050001-3651964b91a215b6				
		0	1	2
			3	4
				17:45:40
				1912-02-27

Figure 3-9 Write in the S value

As we set the Spindle speed number, and press A+, the current number becomes to a thicker font, it means the default S speed number is the current machining spindle speed which is not from S value from G code file. Press A+ again, the number becomes to a normal font, then cancel it as the default Feeding speed, system will cite the spindle speed from the G code file.

CONT	READY	/local/ball1.nc	+00:00:00	Guest
Axis	Mach	Abs	FRO:	100%
⊙X	10.000	0.000	SRO:	100%
⊙Y	10.000	0.000	JSR:	100%
⊙Z	10.000	0.000	F	0 47999
⊙A	10.000	0.000	S	0 6000
G54 H00 M5 M9 M11				
Software Ver: 2022-05-29-001-NOR				
Network not connected				
ID:04-01050001-3651964b91a215b6				
Start	Pause	Reset	View	MpgGuide
				Spindle
				File...
				17:45:58
				1912-02-27

Figure 3-10 the default S is system Spindle speed

CONT	READY	/local/ball1.nc	+00:00:00	Guest
Axis	Mach	Abs	FRO:	100%
⊙X	10.000	0.000	SRO:	100%
⊙Y	10.000	0.000	JSR:	100%
⊙Z	10.000	0.000	F	0 47999
⊙A	10.000	0.000	S	0 6000
G54 H00 M5 M9 M11				
Software Ver: 2022-05-29-001-NOR				
Network not connected				
ID:04-01050001-3651964b91a215b6				
Start	Pause	Reset	View	MpgGuide
				Spindle
				File...
				17:45:52
				1912-02-27

Figure 3-11 the S from G code is system Spindle speed

### 3.2.7 Coordinate system management

In the Coordinate system management we can set the offset and select the current coordinate system.

Press Tab key till G54 is highlighted by Flashing red and blue color. Press A+/A- key to jump up the window g54~g59 coordinate system management. Press Y+/Y- and X+/X- to select the grid. Short press enter key to make the grid is editable, we can move the cursor by X+/X- and increase or decrease the current position number by Y+/Y- key, also you can use the number key to input the numbers directly. And then long press the enter to confirm the setting and exit the window of “coordinate system management”.

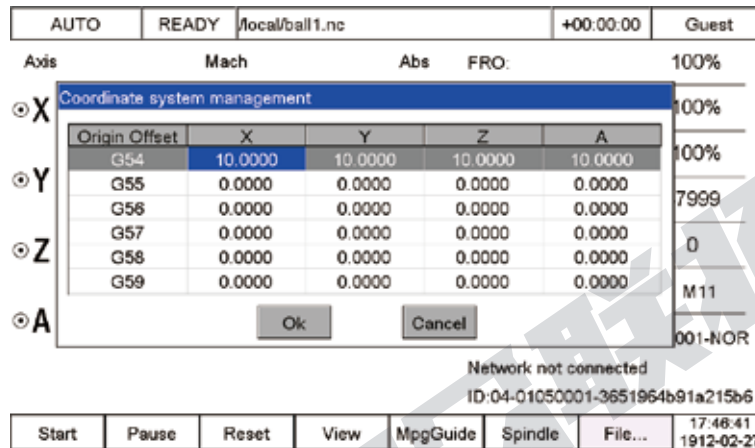

Figure 3-12 Coordinate system management window

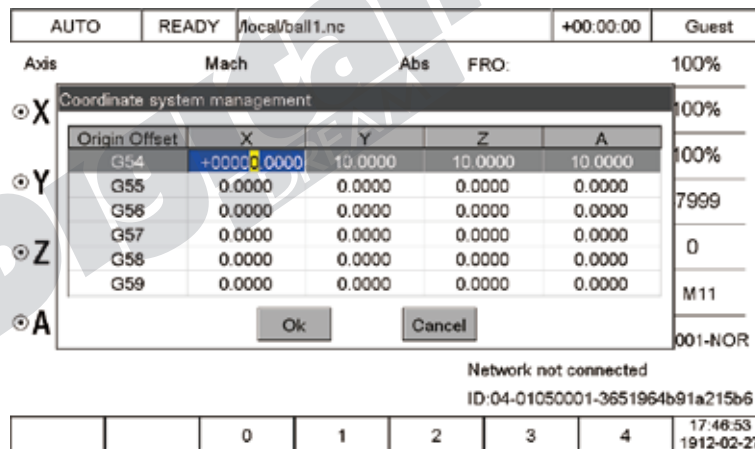

Figure 3-13 The grid is editable

### 3.2.8 Tool management

By the tool management, we can input the Tool length compensation, tool length wear, Tool diameter, and diameter wear. By the values we can reduce the tool errors which made by tool change and cutter wear.

Press Tab key till G54 is highlighted by Flashing red and blue color. Press A+/A- key to jump up the window g54~g59 coordinate system management. Press Y+/Y- and X+/X- to select the grid. Short press enter key to make the grid is editable, we can move the cursor by X+/X- and increase or decrease the current position number by Y+/Y- key, also you can use the number key to input the numbers directly. And then long press the enter to confirm the setting and exit the window of “coordinate system management” .

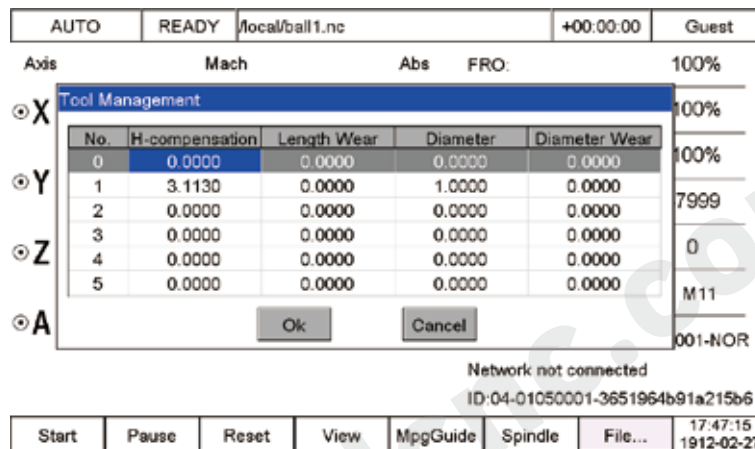

Figure 3-14 Tool management Page

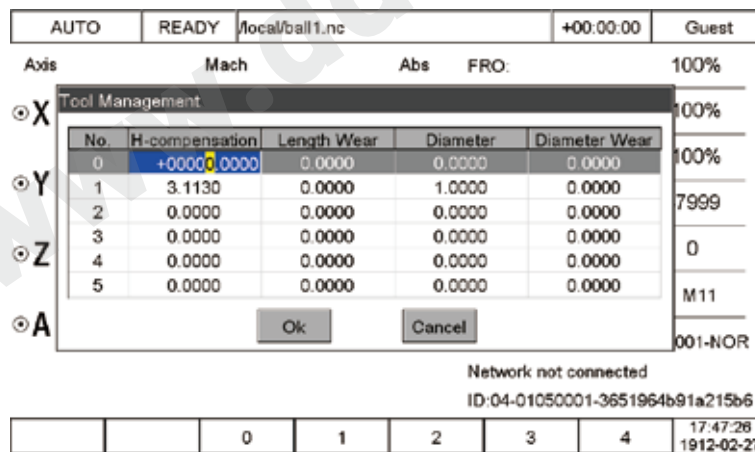

Figure 3-15 Edit the numbers

### 3.3.9 M5/M9/M11

Press Tab key till M5 is highlighted by Flashing red and blue color. Press A+/A- key to switch between the start and stop the spindle.

Press Tab key till M9 is highlighted by Flashing red and blue color. Press A+/A- key to switch between the start and stop the coolant.

Press Tab key till M11 is highlighted by Flashing red and blue color. Press A+/A- key to switch between the start and stop the Lubricant.

### 3.3 Menu function on the Main page

DDCS V4.1 kept the same functions as DDCS V3.1, and also added new Features. By the parameter #313 to define the shift key as Menu key, we press the Shift key and can see that there are new feature list. Here we describe these new features one by one.

The drawing below shows the tree structure of the Menu functions.

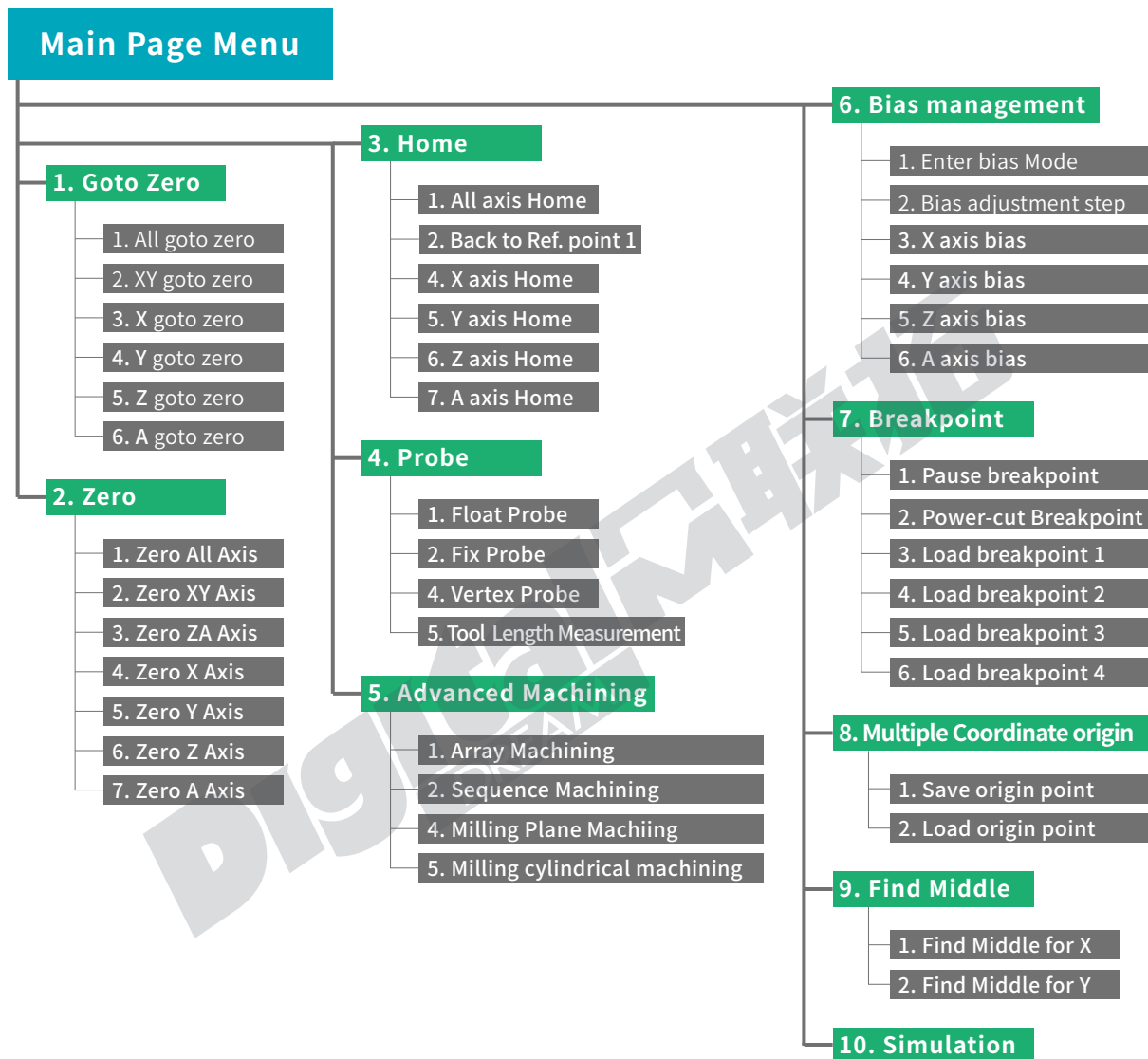

Figure 3-16 Tree Structure of Menu fancies on Main page

### 3.3.1 Goto Zero

In the Sub-Menu of the Shift key, we can select sub-menu of “Goto Zero” By Y+/Y-, and press enter to the selection list of the “Goto Zero”. Here are 6 goto zero orders for selection, the users can select by Y+/Y- and press enter to execute, if press Cancel key, then exit from the sub-menu.

CONT	READY	local/ball1.nc	+00:00:00	Guest
Axis	Mach	Abs	Goto zero submenu	
⊗X	38.515	28.515	All axis goto zero	
⊗Y	73.609	63.609	XY axis goto zero	
⊗Z	-11.465	-21.465	X axis goto zero	
⊗A	80.120	70.120	Y axis goto zero	
			Z axis goto zero	
			A axis goto zero	
Start	Pause	Reset	View	MpgGuide
			Spindle	File...
				18:38:33
				1912-02-27

Figure 3-17 Sub-Menu of Goto Zero

CONT	READY	local/ball1.nc	+00:00:00	Guest
Axis	Mach	Abs	FRO:	100%
⊗X	10.000	0.000	SRO:	100%
⊗Y	10.000	0.000	JSR:	100%
⊗Z	10.000	0.000	F	0 47999
⊗A	10.000	0.000	S	0 6000
			G54	H00 M5 M9 M11
			Software Ver: 2022-05-29-001-NOR	
			Local disk:\192.168.2.5\cncdisk	
			ID:04-01050001-3651964b91a215b6	
Start	Pause	Reset	View	MpgGuide
			Spindle	File...
				18:38:44
				1912-02-27

Figure 3-18 All axis go to zero

### 3.3.2 Zero

In the Sub-Menu of the Shift key, we can select sub-menu of “Zero” By Y+/Y-, and press enter to the selection list of the “Zero”. Here are 7 zero orders for selection, the users can select by Y+/Y- and press enter to execute, if press Cancel key, then exit from the sub-menu.

CONT	READY	local/ball1.nc	+00:00:00	Guest
Axis	Mach	Abs	Zero submenu	
⊗X	107.944	97.944	All axis zero	
⊗Y	95.044	85.044	XY axis zero	
⊗Z	31.697	21.697	ZA axis zero	
⊗A	-39.618	-49.618	X axis zero	
			Y axis zero	
			Z axis zero	
			A axis zero	
Start	Pause	Reset	View	MpgGuide
			Spindle	File...
				18:38:35
				1912-02-27

Figure 3-19 Sub-menu of Zero



CONT	READY	/local/ball1.nc	+00:00:00	Guest
Axis	Mach	Abs	FRO:	100%
⊗ X	107.944	0.000	SRO:	100%
⊗ Y	95.044	0.000	JSR:	100%
⊗ Z	31.697	0.000	F	0 47999
⊗ A	-39.618	0.000	S	0 6000
G54 H00 M5 M9 M11				
Software Ver: 2022-05-29-001-NOR				
Local disk:\192.168.2.5\ncdisk				
ID:04-01050001-3651964b91a215b6				
Start	Pause	Reset	View	MpgGuide
Spindle	File...	18:38:44	1912-02-27	

Figure 3-20 Zero all axis

### 3.3.3 Home

In the Sub-Menu of the Shift key, we can select sub-menu of “Home” By Y+ / Y-, and press enter to the selection list of the “Home”. Here are 9 zero orders for selection, the users can select by Y+ / Y- and press enter to execute, if press Cancel key, then exit from the sub-menu.

In the sub-menu of Home, we added 4 “Back to references point” selection. In Home Parameters of Parameters Page, we can define the 4 mechanical references points position, and execute in the sub-menu, very effective and convenient.

CONT	READY	/local/ball1.nc	+00:00:00	Guest
Axis	Mach	Abs	Home submenu	
⊗ X	10.000	-97.944	All axis home	
⊗ Y	23.145	-71.899	Back to reference point 1	
⊗ Z	-183.383	-215.080	X axis home	
⊗ A	10.000	49.618	Y axis home	
			Z axis home	
			A axis home	
			Back to reference point 2	
			Back to reference point 3	
Start	Pause	Reset	View	MpgGuide
Spindle	File...	18:43:26	1912-02-27	

Figure 3-21 Sub-menu of Home

CONT	READY	/local/ball1.nc	+00:00:00	Guest
Axis	Mach	Abs	FRO:	100%
⊙ X	10.000	0.000	SRO:	100%
⊙ Y	10.000	0.000	JSR:	100%
⊙ Z	10.000	0.000	F	0 47999
⊙ A	10.000	0.000	S	0 6000
G54 H00 M5 M9 M11				
Software Ver: 2022-05-29-001-NOR				
Network not connected				
ID:04-01050001-3651964b91a215b6				
Start	Pause	Reset	View	MpgGuide
Spindle	File...	18:12:06	1912-02-27	

Figure 3-22 Home all axis, notify the Home symbol



### 3.3.4 Probe

The tools will be worn down after long time working, or during the processing the users need to change another cutters to finish job, we need to measure the new position of the cutter point. In DDCS V4.1 control system, we supply Floating Probe, Fix Probe, Vertex Probe and Tool Length (H) measurements to the operator.

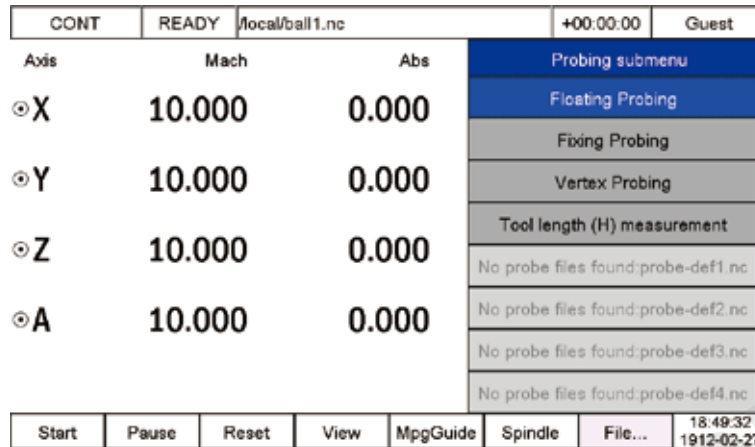

Figure 3-23 Probe sub-menu

#### 3.3.4.1 Floating Probe

The floating Probe is to place a floating sensor on the surface of the workpiece, and the tool slowly comes down to the sensor. Because the sensor is floating on the workpiece, it is called floating probe. The floating probe is used to set the origin point of the Z axis. Before execute the floating probe, the users need to measure the thickness of the sensor and fill in the this value.

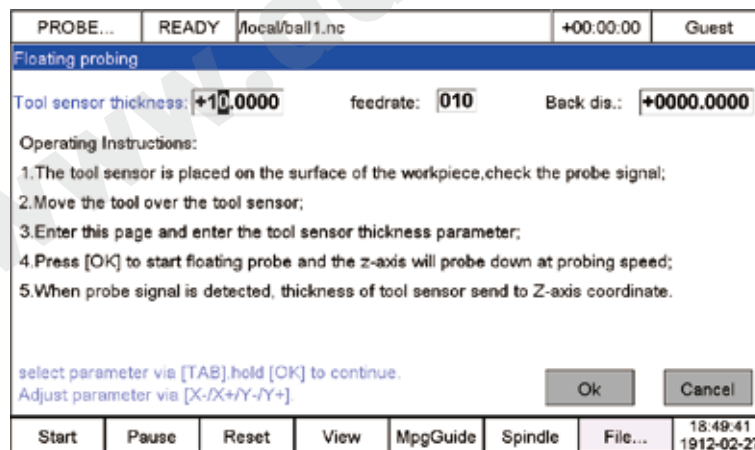

Figure 3-24 Floating Probe Management Page

When input the number, we can move the cursor by X+/X- and increase or decrease the number by Y+/Y-. Press Tab key to go to next column, or you short press Enter cursor go to next column. After setting well, Long press Enter key the system start to execute the floating probe.

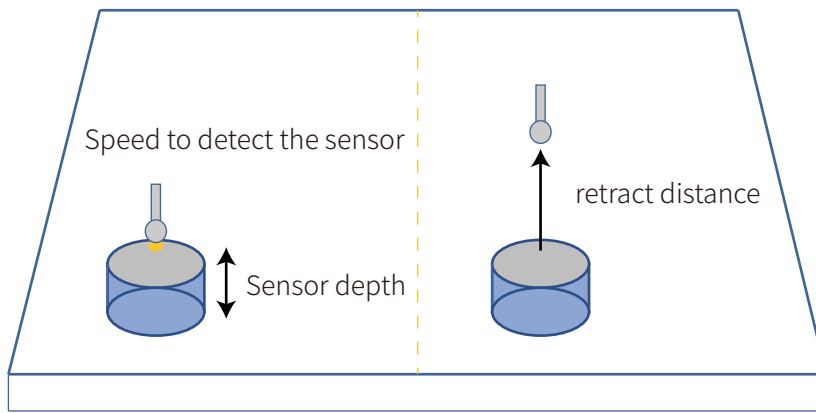

Figure 3-25 Floating Probe Sequence

### 3.3.4.2 Fixed probe

The fixed probe refers to the probe operation on a fixed position on the machine, the probe sensor is installed on a fixed position, so it is called fixed probe. The users must determine the Probe mechanical position of XYZ axis, safety height, then can execute the fixed probe.

Before fixed probe, no forget to Home all axis.

The operation of numbers input as same as the Floating probe.

PROBE...	READY	/local/ball1.nc	+00:00:00	Guest				
<b>Fixing probing</b>								
feedrate:	<input type="text" value="010"/>	Probing position(Mach) X:	<input type="text" value="+0020.0000"/>					
Back dis.:	<input type="text" value="+00.0000"/>	Probing position(Mach) Y:	<input type="text" value="+0020.0000"/>					
Safety height(Mach):	<input type="text" value="+0020.0000"/>	Probing position(Mach) Z:	<input type="text" value="+0010.0000"/>					
<b>Operating Instructions:</b> 1.Tool sensor is mounted in fixed position on machine,HOME is required before probing; 2.Check the probe signal; 3.Enter this page and set the relevant parameters correctly; 4.Press [OK] to start fixed probing,rise Z-axis to safe height, first move XY-axis, then move Z-axis to probing position,then downward at probing feedrate,when probe signal checked,Z-axis Mach coordinates send to the Z-axis bias,Then Z-axis back and fixed probing is finished. <b>Note: When the position of tool sensor on machine changes, please perform fixed probing!</b> select parameter via [TAB],hold [OK] to continue. Adjust parameter via [X-/X+/Y-/Y+].								
				<input type="button" value="Ok"/>	<input type="button" value="Cancel"/>			
Start	Pause	Reset	View	MpgGuide	Spindle	File...	18:58:52	1912-02-27

Figure 3-26 Fixed Probe Management Page

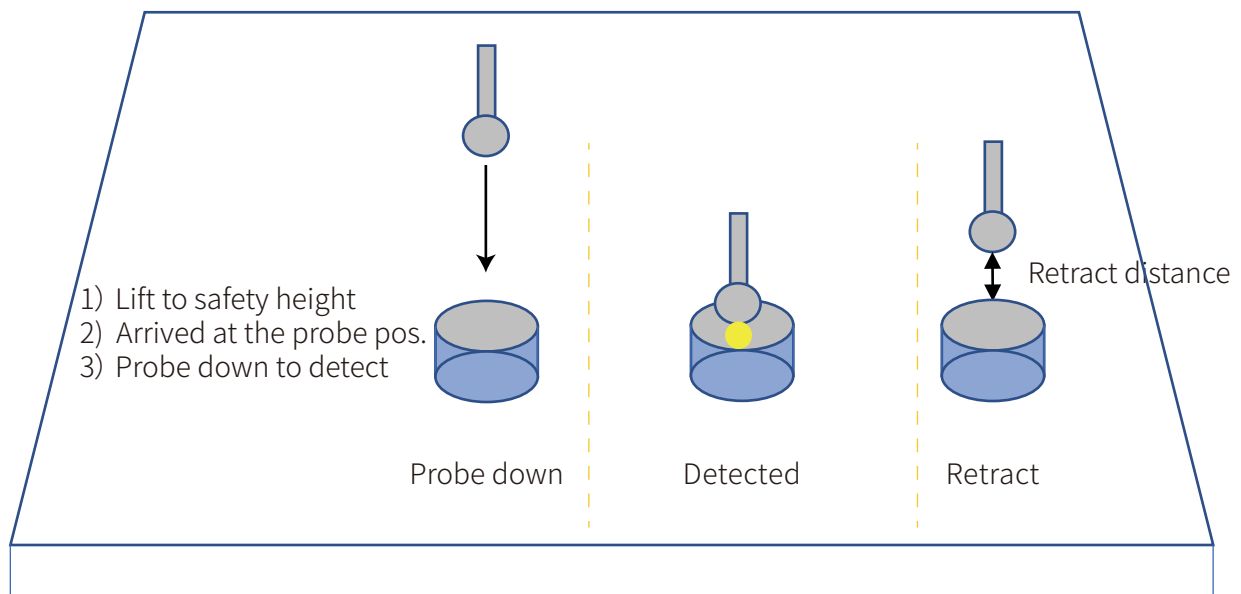

Figure 3-27 Fixed Probe Sequence

### 3.3.4.3 Vertex Probe

The difference between Vertex probe and Floating/fixed probe, Floating/fixed probe only can calibrate the Z axis position, but Vertex probe can calibrate X/Y and Z axis position. For Vertex probe, we need the probe sensor must be a metal square with no coating on the surface, and the sensor must be a good conductive body and the XYZ three planes are vertically at 90 degrees.

PROBE...	READY	/local/ball1.nc	+00:00:00	Guest				
<b>Vertex Probing</b>								
feedrate: 010 diameter: +04.0000 toolplate thick: X+09.0000 Y+09.0000 Z+09.0000								
Operating Instructions:								
1. Perform Z-axis plane probing, Z-axis plane coordinate is set to:	+0020.0000							
2. Z-axis back, Back distance is set to:	+10.0000							
3. X-axis moves to outside of workpiece edge, Moving distance is set to:	+0010.0000							
4. Z-axis drops below surface of workpiece, Moving distance is set to:	+25.0000							
5. Perform X-axis plane probing, X-axis plane coordinate is set to:	+0010.0000							
6. X-axis back, Back distance is set to:	+0010.0000							
7. Z-axis back, Y-axis moves to outside of workpiece edge, Moving distance is:	+0025.0000							
9. Z-axis drops, Perform Y-axis plane probing, Y-axis plane coordinate is:	+0010.0000							
10. Y-axis back, Back distance is set to:	+0010.0000							
11. Z-axis drops, XY axis moves to vertex of workpiece, Probing complete.								
select parameter via [TAB], hold [OK] to continue.								
Adjust parameter via [X-/X+/Y-/Y+].								
				Ok	Cancel			
Start	Pause	Reset	View	MpgGuide	Spindle	File...	19:04:17	1912-02-27

Figure 3-28 Vertex Probe Management Page

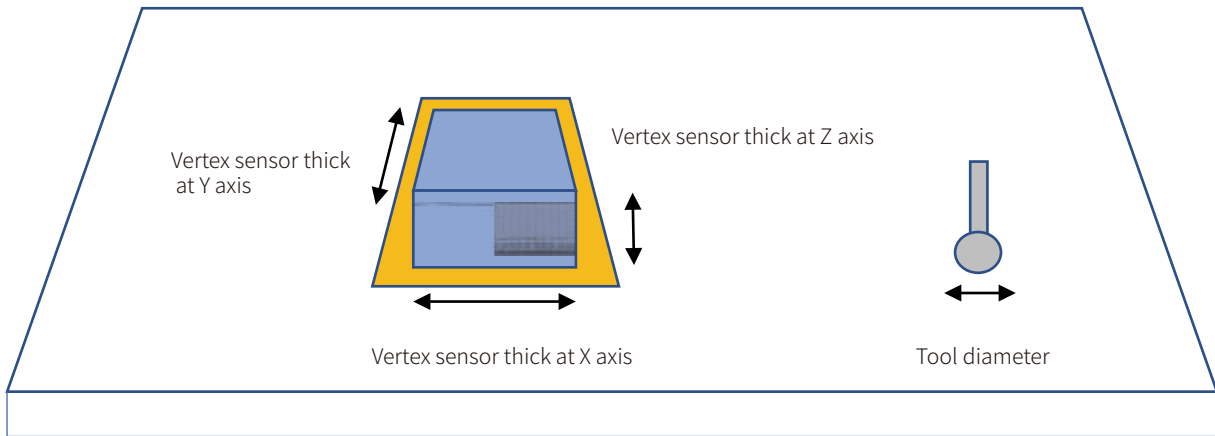

Figure 3-29 Before vertex probe the data need to collect

The values needed to write in:

1. Perform Z-axis plane probing, Z-axis plane coordinate is set to:
2. Z-axis back, Back distance is set to:
3. X-axis moves to outside of workpiece edge, Moving distance is set to:
4. Z-axis drops below surface of workpiece, Moving distance is set to:
5. Perform X-axis plane probing, X-axis plane coordinate is set to:
6. X-axis back, Back distance is set to:
7. Z-axis back, Y-axis moves to outside of workpiece edge, Moving distance is:
9. Z-axis drops, Perform Y-axis plane probing, Y-axis plane coordinate is:
10. Y-axis back, Back distance is set to:
11. Z-axis drops, XY axis moves to vertex of workpiece, Probing complete.

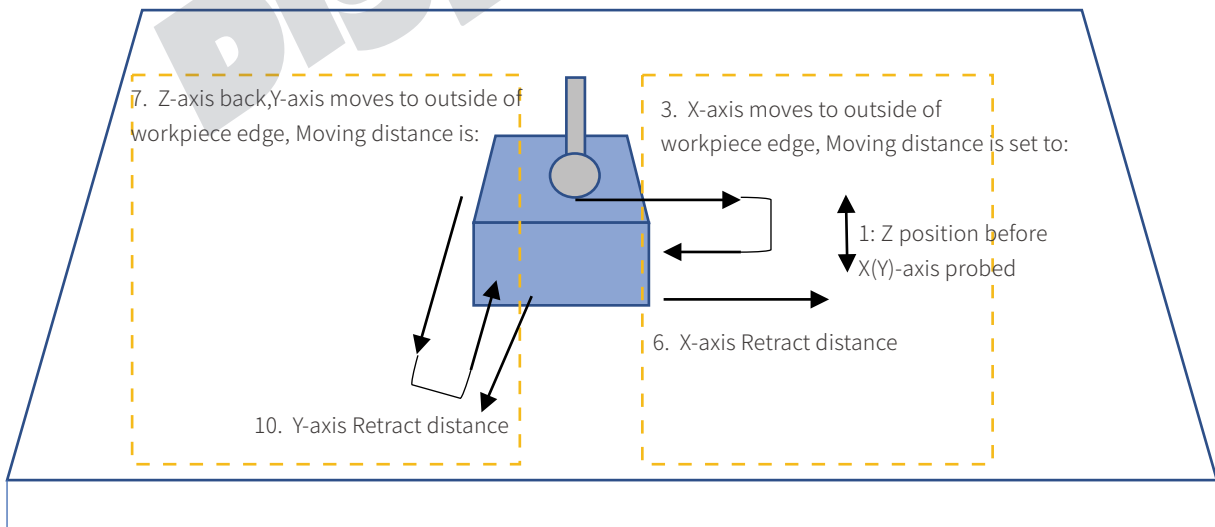

Figure 3-30 Detection Sequence in Vertex probe

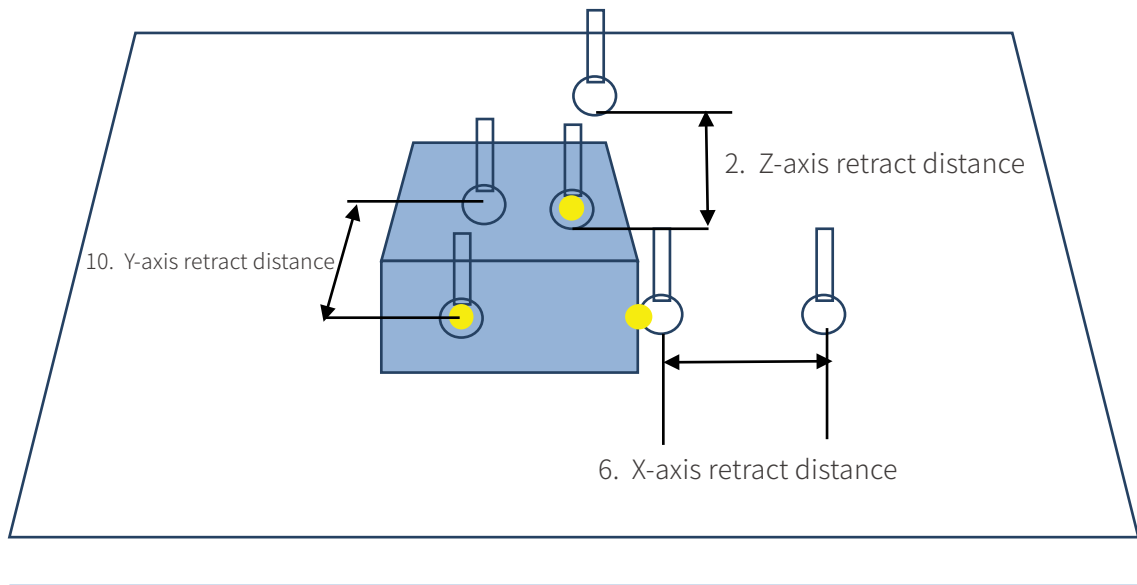

Figure 3-31 Retract Sequence in Vertex probe

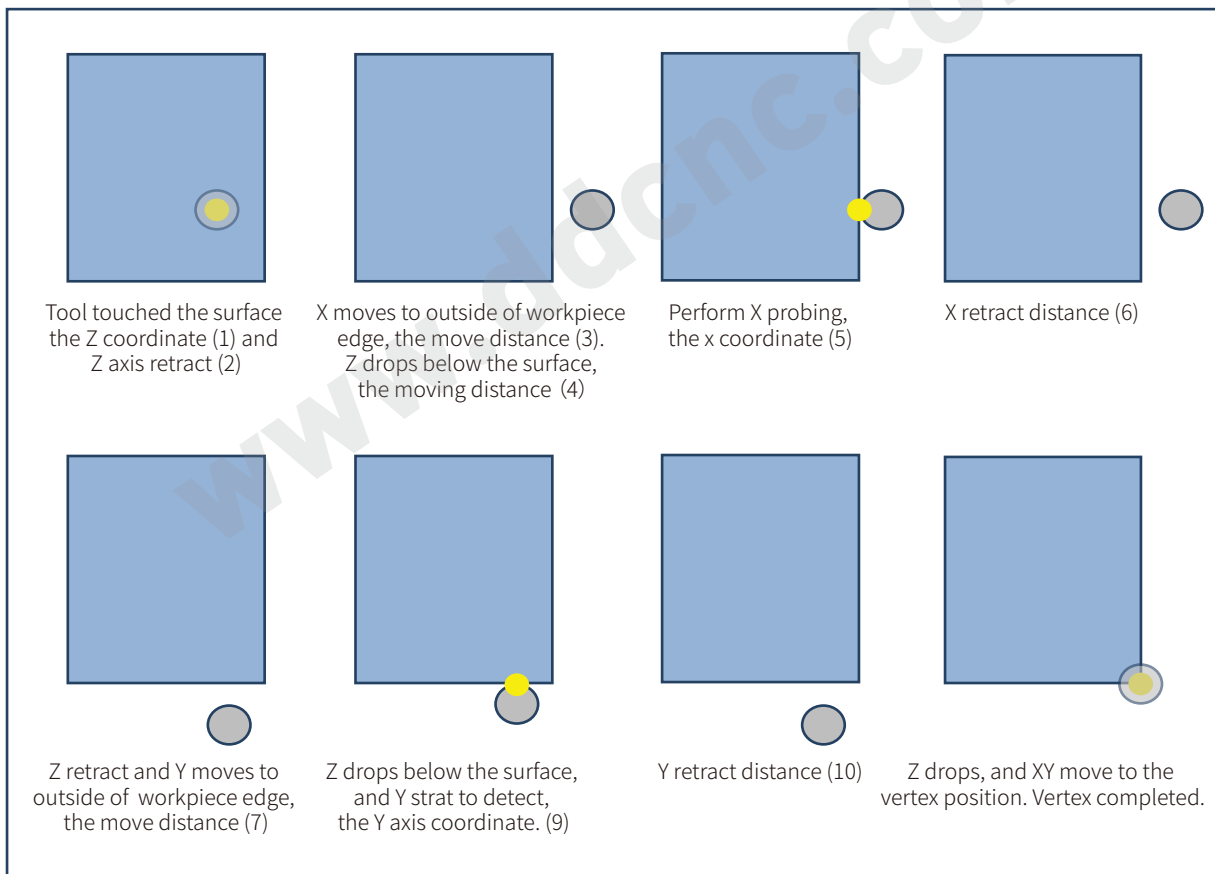

Figure 3-32 Complete steps in Vertex Probe

### 3.3.4.4 Tool length (H) Measurement

The tools position changes caused by the tool wear or reinstallation of the tools. After the establishment and execution of the tool position compensation, no need to create a new program to fix new situation. Generally, we use the cutter tip as the control point and the length of the tool is the baseline length. If you replace the tool during processing, we need to make the length compensation. The compensation value is equal to the length difference between the new tool length and the baseline length. In addition, when the measurement reference surface of the baseline tool length is used as the control point, the tool length compensation always exists. No matter which tool you will use system must execute the absolute length compensation.

In the program, the length compensation command is G43 H\_. G43 is tool length compensation, H\_ is the tool number in the CNC machine, we can use G49 to cancel the compensation.

1) Use the spindle end surface to directly contact the upper surface the workpiece, and go to Z0 in G54. Then system calculate the Z mach coordinate value.

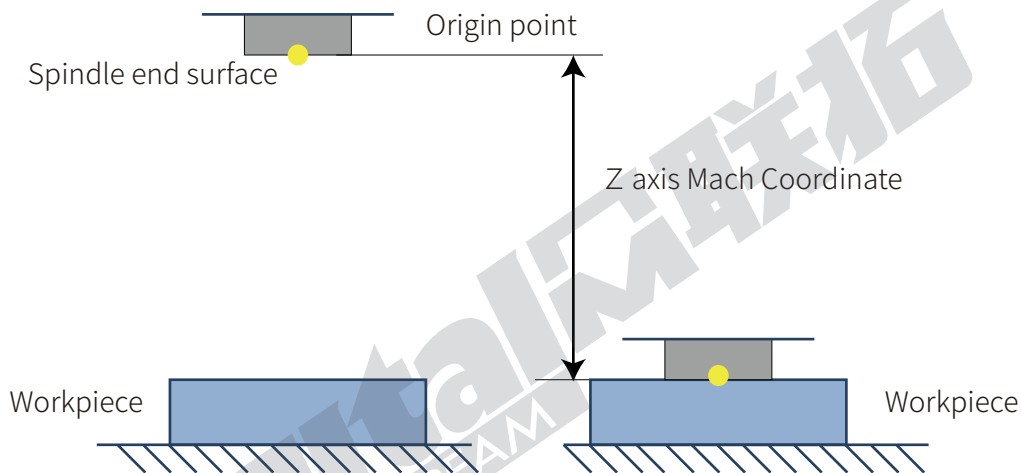

Figure 3-33 calculate the Z mach coordinate value

2) The control system go to “Shift – Probe – Tool length (H) measurement”

3) Firstly measure the baseline length. Install the baseline tool, and in the page of “Tool length (H) measurement” we choose how to measure the length, by floating probe or fixed probe, and write in the according numbers and execute.

When the baseline tool probed down and contacted the surface of the workpiece, the system can calculate the baseline length=Z mach coordinate - detect distance.

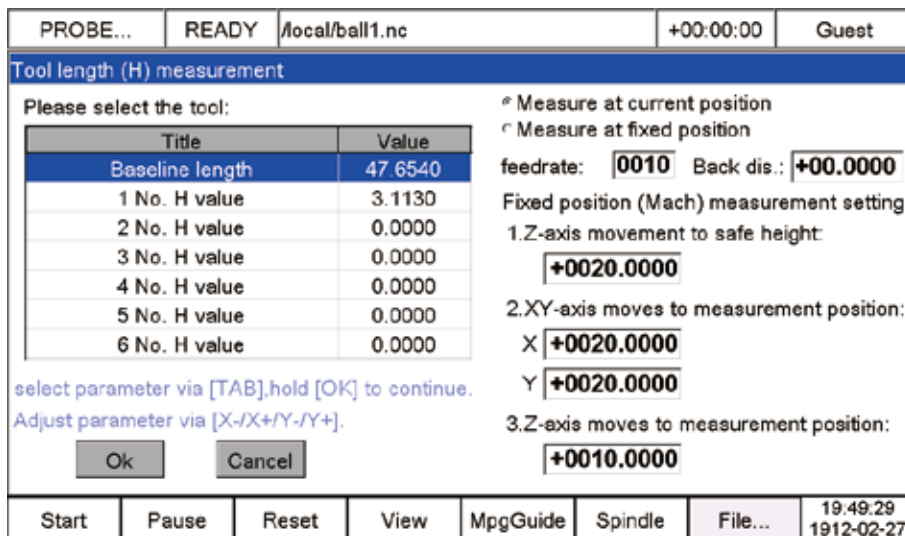

Figure 3-34 Tool Length (H) Measurement Page

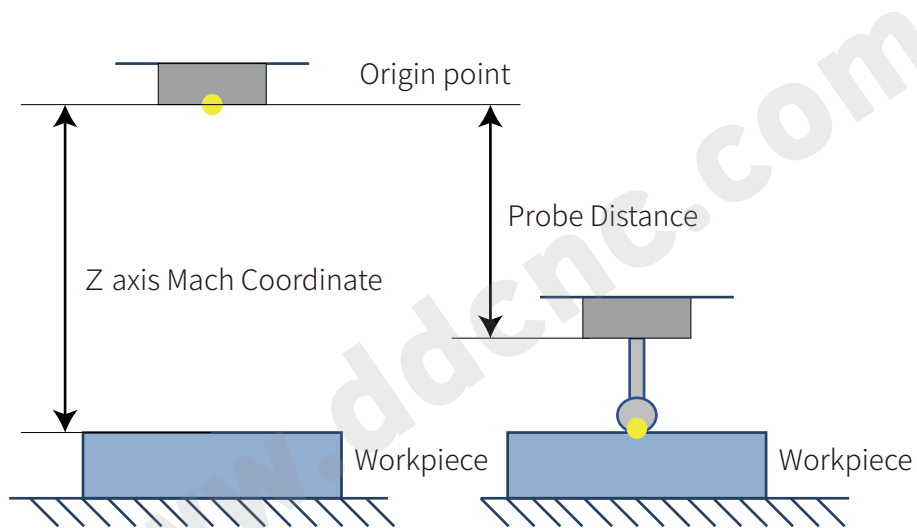

Figure 35 Measure the Baseline length

4) Now we start the measure the No. 1 tool compensation. By Y+/Y- we select “1 No. H value” and long press the enter key, tool starts to detect down and when it touched the surface of the work-piece, system can calculate the length difference and write the difference to No.1 tool compensation.

5) By same methods to measure No.2 tool and No. 3 tool.

PROBE...	READY	/local/ball1.nc	+00:00:00	Guest
Axis	Mac			100%
⊙X	10.00			100%
⊙Y	10.00			100%
⊙Z	58.34		0	47999
⊙A	10.00		0	0
				02 M5 M9 M11
				Ver: 2022-05-29-001-NOR
				c:\192.168.2.5\ncdisk
				ID:04-01050001-3651964b91a215b6
Start	Pause	Reset	View	MpgGuide
Spindle	File...			20:03:24
				1912-02-27

Figure 3-36 The system calculate the Tool 2 compensation and write in

### 3.3.5 Advanced machining

连续	空闲	/local/ball1.nc	-00:03:55	超级管理员
轴	机械坐标	工件坐标	高级加工子菜单	
⊙X	3.327	3.327	高级启动策略	
⊙Y	5.080	4.080	阵列加工	
⊙Z	8.582	-1.418	序列加工	
⊙A	0.000	0.000	铣平面加工	
			铣圆柱加工	
启动	暂停	复位	视图	手轮引导
主轴启停	文件页面			19:02:45
				1912-02-27

Figure 3-37 Sub-Menu of Advanced machining



### 3.3.5.1 Advanced startup

In the page, we can execute “Specified line” and “closest location” .

Specified line: We can enter the line number, the system will process from this line.

Closest Location: System will search the closest point from current position and process from this closest location.

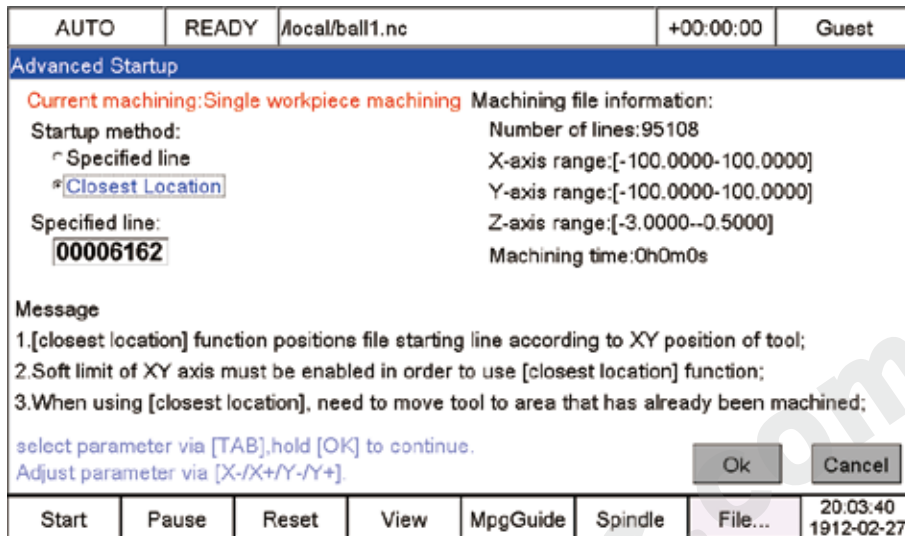

Figure 3-38 Advanced startup page

### 3.3.5.2 Array machining

Write in properly of “Array Rows”, “Array Columns”, “Row spacing”, “Column spacing”, “Rotation angle”, “Rotation Center X”, “Rotation Center Y”.

When input the number, we can move the cursor by X+/X- and increase or decrease the number by Y+/Y-. Press Tab key to go to next column, or you short press Enter cursor go to next column. After setting done, Long press Enter key the system start to execute.

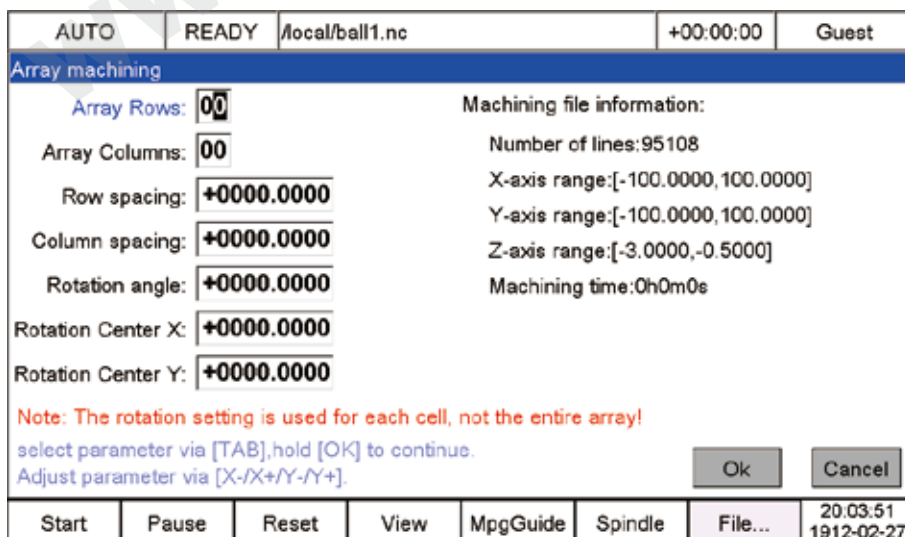

Figure 3-39 Array machining page

### 3.3.5.3 Sequence machining

By “Origin-X”, “Origin-Y”, “Origin-Z”, “Origin-A”, “Rotate-angle”, “R-Center-X”, “R-Center-Y” the 7 parameters, the system execute the sequence machining.

The values about sequence machining cannot write in the controller by keys. We need to find out the template.txt file in the system software, and write in the values there. Add these 7 values in the file and separate them by the space key.

The software with new “template.txt” file, system update with it and we can check it out.

```
template - Notepad
File Edit Format View Help
50 0 0 0 45 50 25
50 0 0 0 -45 50 25
50 0 0 0 0 50 25
50 0 0 0 45 50 25
50 0 0 0 -45 50 25
50 0 0 0 0 50 25
50 0 0 0 45 50 25
50 0 0 0 -45 50 25
50 0 0 0 0 50 25
50 0 0 0 45 50 25
50 0 0 0 -45 50 25
50 0 0 0 0 50 25
50 0 0 0 45 50 25
50 0 0 0 -45 50 25
50 0 0 0 0 50 25
50 0 0 0 45 50 25
50 0 0 0 -45 50 25
50 0 0 0 0 50 25
50 0 0 0 45 50 25
50 0 0 0 -45 50 25
50 0 0 0 0 50 25
```

Figure 3-40 Write the 7 parameter to “template.txt”

The software with new “template.txt” file, system update with it and we can check it out at the page of Sequence machining.

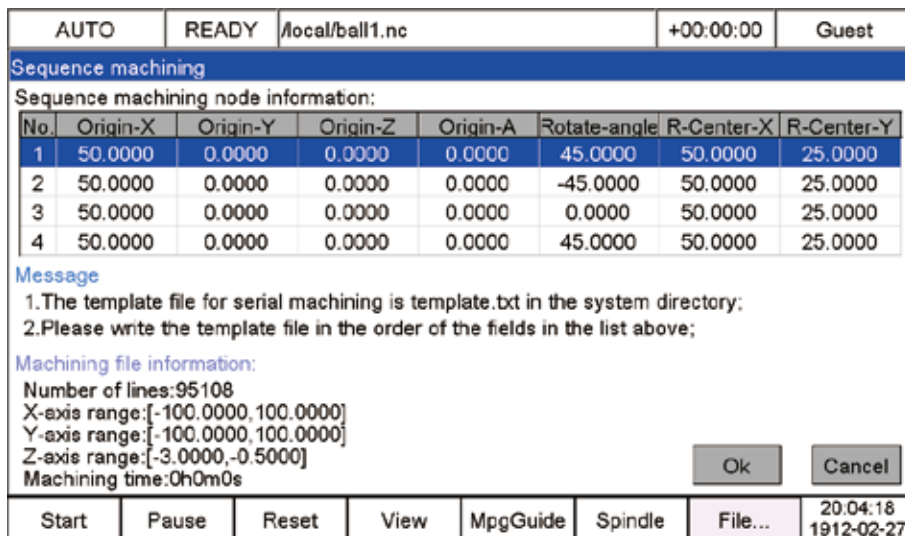

Figure 3-41 Sequence machining Page

### 3.3.5.4 Milling Plane Machining

Before Milling Plane machining, no forget to Home all axis.

After all the settings done, long press the Enter key to execute the program. And the program converts to G code and saved to the file of “macroMillRect.nc” in the system software.

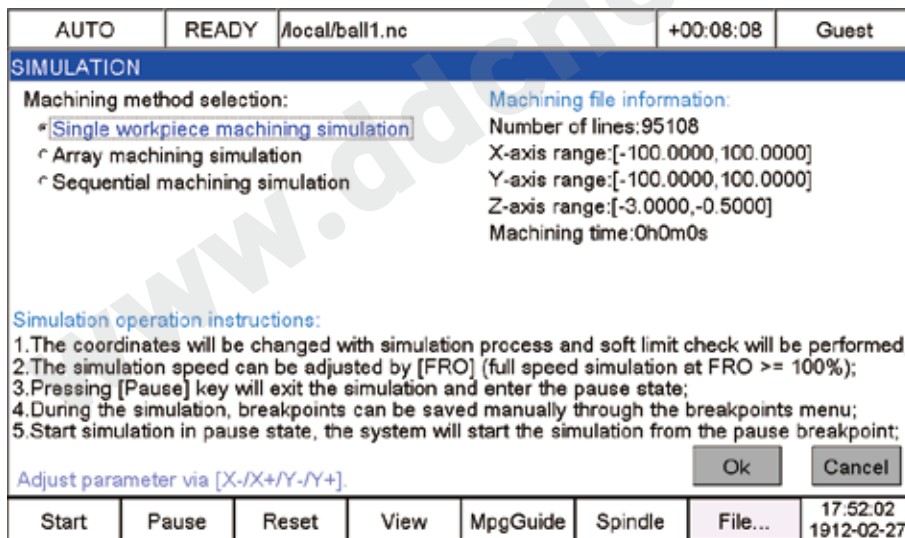

Figure 3-42 Milling Plane Machining Page

### 3.3.5.5 Milling cylindrical machining

Before Milling cylindrical machining, no forget to Home all axis.

After all the settings done, long press the Enter key to execute the program. And the program converts to G code and saved to the file of “macroMillCylinder.nc” in the system software.

AUTO	READY	/ddcsv4/macroMillCylinder.nc	+00:00:03	Admin			
<b>Milling cylindrical machining</b>							
Cylindrical central axis: roughcast diameter: <b>+0000.0000</b>		Cylinder diameter: <b>+0000.0000</b>					
↳ X-axis	Workpiece length: <b>+0000.0000</b>	layer depth: <b>+0000.0000</b>					
↳ Y-axis	Cutter diameter: <b>+00.0000</b>	Tool tip spacing: <b>+00.0000</b>					
	Drilling feedrate: <b>000100</b>	Milling feedrate: <b>000500</b>					
<b>Tips:</b> 1. Press [Cancel] to exit page, then simulate to ensure the safety of machining; 2. The milling file is macroMillCylinder.nc in the system directory, It is written using Class B-macros, When file name is prefixed with macro, system will automatically enter macro parsing mode. Combined with macro windows, users can customize functions; select parameter via [TAB], hold [OK] to Adjust parameter via [X-/X+/Y-/Y+].							
				Ok	Cancel		
Start	Pause	Reset	View	MpgGuide	Spindle	File...	18:11:21 1912-02-27

Figure 3-43 Milling cylindrical machining Page

### 3.3.6 Bias Management

When entered Bias management mode, the system mode turns to Bias mode, we can check it at the column 10. Now by the key of X+/X-, Y+/Y-, Z+/Z-, A+/A-, we can easily adjust the Bias of each axis, each press we make is one distance of “Bias adjustment step”.

CONT	READY	/ddcsv4/macroMillCylinder.nc	+00:00:07	Admin			
Axis	Mach	Abs	<b>Bias management submenu</b>				
⊙ X	10.000	0.000	<b>Enter bias management mode</b>				
			<b>Bias adjustment step</b>				
⊙ Y	10.000	0.000	X axis bias				
			Y axis bias				
⊙ Z	5.000	-5.000	Z axis bias				
			A axis bias				
⊙ A	10.000	0.000					
Start	Pause	Reset	View	MpgGuide	Spindle	File...	18:11:38 1912-02-27

Figure 3-44 Enter Bias Management Mode

BIAS		READY	/ddcsv4/macroMillCylinder.nc	+00:00:07	Admin		
Axis	Bias	Abs	FRO:	100%			
⊙X	0.000	0.000	SRO:	100%			
⊙Y	0.000	0.000	JSR:	100%			
⊙Z	47.654	0.000	F	0	47999		
⊙A	0.000	0.000	S	0	8000		
			G54	H00	M5 M9 M11		
Bias adjustment mode							
[axis ctrl key] adjust axis bias							
[mode key] set step:1.0000							
Start	Pause	Reset	View	MpgGuide	Spindle	File...	18:12:43 1912-02-27

Figure 3-45 System is in Bias Mode

The Bias trip step range in Bias adjustment step, is from 0.0001 to 1. The Bias of each axis, the range is from 0.0001 to 9999.9999.

BIAS		READY	/ddcsv4/macroMillCylinder.nc	+00:00:07	Admin		
Axis	Bias	Abs	FRO:	100%			
⊙X	0.000	0.000	SRO:	100%			
⊙Y	0.000	0.000		0	47999		
⊙Z	47.654	0.000		0	8000		
⊙A	0.000	0.000	G54	H00	M5 M9 M11		
Bias adjustment mode							
[axis ctrl key] adjust axis bias							
[mode key] set step:1.0000							
		0	1	2	3	4	18:13:17 1912-02-27

Figure 3-46 Bias Trim Step

BIAS		READY	/ddcsv4/macroMillCylinder.nc	+00:00:07	Admin		
Axis	Bias	Abs	FRO:	100%			
⊙X	0.000	0.000	SRO:	100%			
⊙Y	0.000	0.000		0	47999		
⊙Z	47.654	0.000		0	8000		
⊙A	0.000	0.000	G54	H00	M5 M9 M11		
Bias adjustment mode							
[axis ctrl key] adjust axis bias							
[mode key] set step:1.0000							
		0	1	2	3	4	18:13:36 1912-02-27

Figure 3-47 X axis Bias Step

If we didn't exit from the Bias management mode, the controller will be always in Bias mode. Only after we exit from the Bias management mode, we can operate other functions.

### 3.3.7 Breakpoint

In DDCS V4.1 there is Pause breakpoint, Power-down breakpoint, and 4 record breakpoint.

Pause Breakpoint: The system can remember the line number of last pause, the users can select to process from pause breakpoint.

Power-down Breakpoint: The system can remember the line number when power-cut, the users can select to process from the power-cut line.

Recorded breakpoint: The uses can record the breakpoint when system is processing a program. The system will make a record of the program line and create a breakpoint. We can record 4 breakpoints.

CONT	READY	/ddcsv4/macroMillRect.nc	+00:00:08	Guest
Axis	Mach		Breakpoint submenu	
⊙ X	10.000	10	Pause Breakpoint macroMillCylinder.nc 92	
			Power-down Breakpoint macroMillCylinder.nc 92	
⊙ Y	10.000	10	Load breakpoint1 ball1.nc 6162	
			Load breakpoint2 ball1.nc 13698	
⊙ Z	5.000	-5	Load breakpoint3 ball1.nc 17335	
			Load breakpoint4 ball1.nc 21589	
⊙ A	0.000	0		
Start	Pause	Reset	View	MpgGuide Spindle File... 21:03:57 1912-02-27

Figure 3-48 3 kinds breakpoints are created

When the controller is in Ready Mode, we can load the breakpoint.

After loading the breakpoint, we can enter into the load breakpoint page, in the page, the users still can have 3 choices: Go to specified line, go to closest line and go to the breakpoint that you selected.

Long press Enter key to execute.

AUTO	READY	/local/ball1.nc	+00:00:42	Guest
Load breakpoint				
machining method:Single Program mode:Normal Line No.:13698				
Startup method:		Machining file information:		
<input type="radio"/> Specified line <input type="radio"/> Closest Location <input checked="" type="radio"/> Breakpoint		Number of lines:95108 X-axis range:[-100.0000-100.0000] Y-axis range:[-100.0000-100.0000] Z-axis range:[-3.0000--0.5000] Machining time:0h0m0s		
Specified line:				
00013698				
Message				
1.[closest location] function positions file starting line according to XY position of tool;				
2.Soft limit of XY axis must be enabled in order to use [closest location] function;				
3.When using [closest location], need to move tool to area that has already been machined;				
select parameter via [TAB].hold [OK] to continue.				
Adjust parameter via [X-/X+/Y-/Y+].				
				Ok Cancel
Start	Pause	Reset	View	MpgGuide Spindle File... 21:04:12 1912-02-27

Figure 3-49 Load the Breakpoint Page



### 3.3.8 Multiple Coordinate origin

The Multi coordinate by setting different origins, can process the multi-workpiece under the same coordinate system. The user can save the origin point of the workpiece by saving the mechanical coordinates of the origin point. When the users need it just load the coordinate origin.

CONT	READY	local/ball1.nc	+00:00:19	Guest
Axis	Mach	Abs	Main page menu	
⊙X	10.000	0.000	Goto zero...	
⊙Y	10.000	0.000	Zero...	
⊙Z	10.000	0.000	Home...	
⊙A	10.000	0.000	Probe...	
6162 X-2.247 Y4.203			Advanced machining...	
			Bias management...	
			breakpoint...	
			Coordinate origin...	
Start	Pause	Reset	View	MpgGuide
			Spindle	File...
				17:44:10 1912-02-27

Figure 3-50 Multiple Coordinate origin selection

CONT	READY	local/ball1.nc	+00:00:19	Guest
Axis	Mach	Abs	Coordinate origin submenu	
⊙X	10.000	0.000	Save coordinate origin...	
⊙Y	10.000	0.000	Load coordinate origin...	
⊙Z	10.000	0.000		
⊙A	10.000	0.000		
6162 X-2.247 Y4.203				
Start	Pause	Reset	View	MpgGuide
			Spindle	File...
				17:44:18 1912-02-27

Figure 3-51 Sub-menu of Multiple Coordinate origin

STEP	READY	local/ball1.nc	+00:00:19	Guest
Axis	Mach	Abs	Save coordinate origin submenu	
⊙X	110.000	0.000	X10.000 Y10.000 Z10.000 A10.000	
			X60.000 Y60.000 Z10.000 A10.000	
⊙Y	110.000	0.000	X110.000 Y110.000 Z10.000 A10.000	
⊙Z	10.000	0.000	No record	
⊙A	10.000	0.000	No record	
6162 X-2.247 Y4.203			No record	
			No record	
Start	Pause	Reset	View	MpgGuide
			Spindle	File...
				17:47:31 1912-02-27

Figure 3-52 Create the coordinate origins

The users can save a lot of coordinate origins when need just select and load it.

STEP	READY	/local/ball1.nc	+00:00:19	Guest
Axis	Mach	Abs	Load coordinate origin submenu	
⊙X	110.000	100.000	X10.000 Y10.000 Z10.000 A10.000	
			X60.000 Y60.000 Z10.000 A10.000	
⊙Y	110.000	100.000	X110.000 Y110.000 Z10.000 A10.000	
⊙Z	10.000	0.000	No record	
⊙A	10.000	0.000	No record	
6162 X-2.247 Y4.203				
No record				
No record				
No record				
No record				
Start	Pause	Reset	View	MpgGuide Spindle File... 17:47:57 1912-02-27

Figure 3-53 Load the coordinate origin 1

### 3.3.9 Centers

DDCS V4.1 only support find middle for X and Y axis. The Operation:

1. First, place the tool against the x-axis side of the workpiece and zero x-axis;
2. Then place the tool against the other side of the x-axis of the workpiece;
3. Long Press enter key and x-axis origin will be set to center point of the workpiece. Y axis Find center operation as the same.

CONT	READY	/ddcsv4/macroMillCylinder.nc	+00:00:17	Admin
Axis	Mach	Abs	FRO:	100%
⊙X	10.000	0.000	SRO:	100%
⊙Y	10.000	0.000	JSR:	100%
⊙Z	10.000	0.000	F	0 3000
⊙A	10.000	0.000	S	0 12000
G54 H00 M5 M9 M11				
Software Ver: 2022-05-29-001-NOR				
Local disk:\192.168.2.5\ncdisk				
ID:04-01050001-3651964b91a215b6				
92 N14G91G1A360				
Start	Pause	Reset	View	MpgGuide Spindle File... 21:36:18 1912-02-27

Figure 3-54 place the tool against the x-axis side of the workpiece and zero x-axis

STEP	READY	/ddcsv4/macroMillCylinder.nc	+00:00:17	Admin
Axis	Mach	Abs	Centers submenu	
⊙X	110.000	100.000	X axis 1/2	
			Y axis 1/2	
⊙Y	10.000	0.000		
⊙Z	10.000	0.000		
⊙A	10.000	0.000		
92 N14G91G1A360				
Start	Pause	Reset	View	MpgGuide Spindle File... 21:36:42 1912-02-27

Figure 3-55 place the tool against the other side of the x-axis of the workpiece



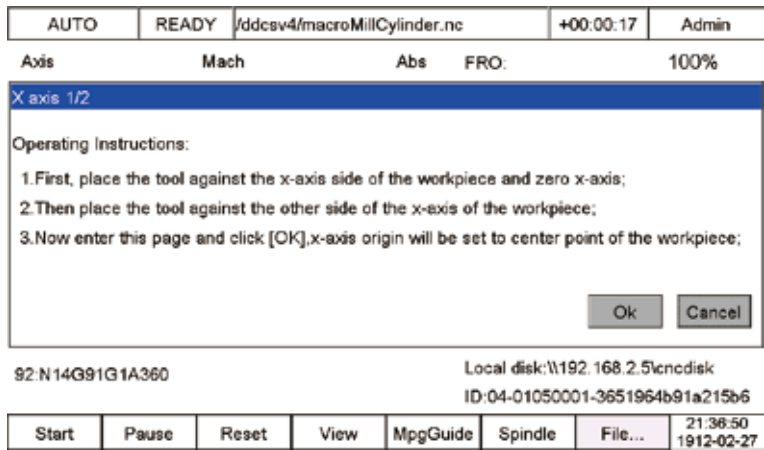

Figure 3-56 Long press the Enter key

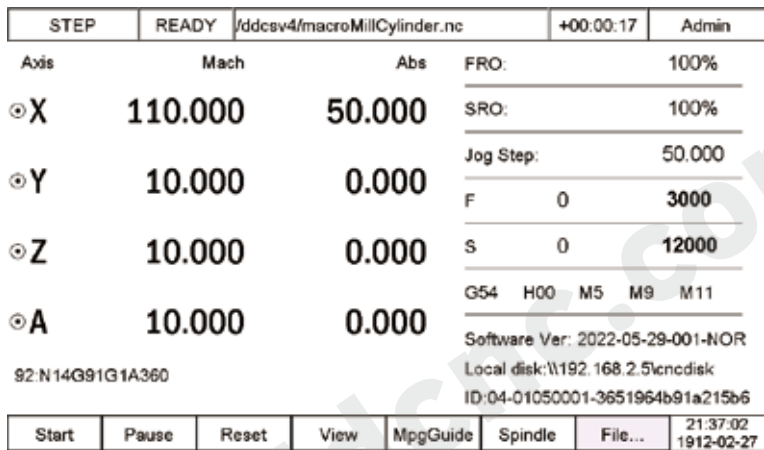

Figure 3-57 Find Middle for X axis completed

### 3.3.10 Simulation

DDCS V4.1 supports the simulation in 3 modes:

Single workpiece machining simulation: Simulate as the program.

Array machining simulation: Firstly Array the program and then simulate

Sequential machining simulation: Firstly array the program and then simulate.

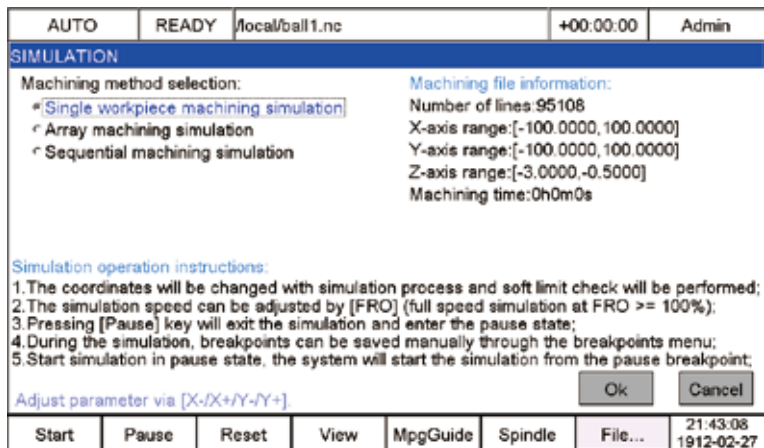

Figure 3-58 Simulation Page

## 3.4 File Management Page

### 3.4.1 File Management Page Introduction

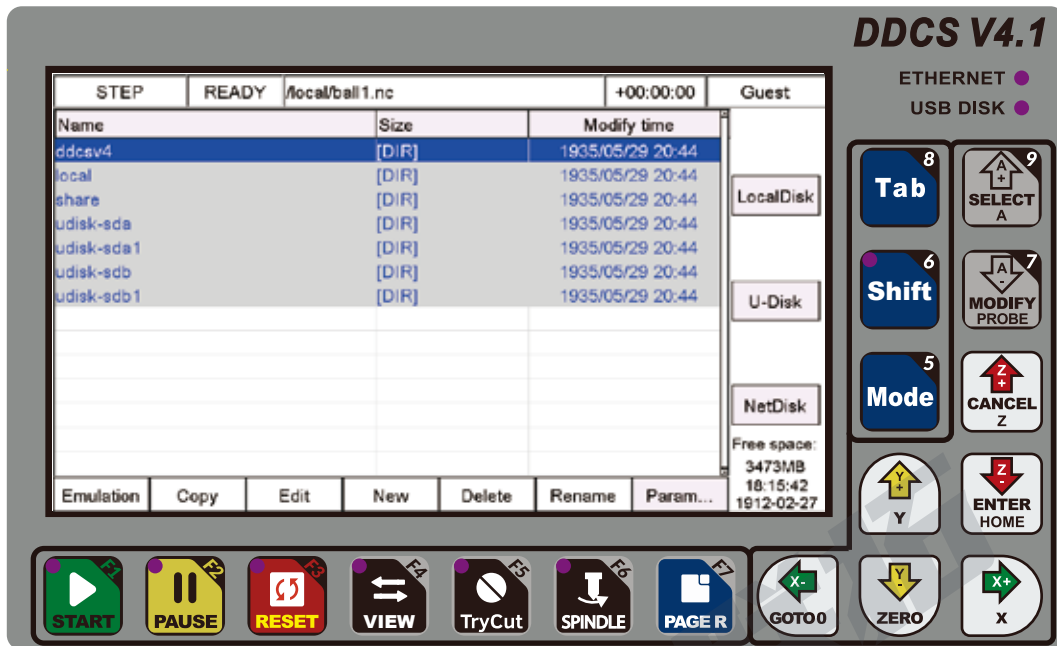

Figure 3-59 File management Page

Press Page R key 1 time and go to File page.

ddcsv4: It is system folder, all the system files are in this folder.

Local: Local folder, we can send the program in this folder.

share: It is the folder when we build the communication with the computer, share folder is created on the host computer. udisk-sda1: USB stick folder. Emulation: After selected the program, press F1 to emulate.

Copy: After selected the program, press F2 to copy. Edit: After selected the program, press F3 to delete. New: Press F4 key to create a new nc file. Delete: After selected the program, press F5 to delete. Rename: After selected the program, press F6 to rename the file. Param: Press this key enter to Parameter Page. LocalDisk: Press Tab key go to Local disk. U-disk : Press Shift key go to USB Disk. NetDisk: Press Mode key, go to Share folder when ethernet communication is built.

And if the “#313 Shift key operation mode” is Menu mode, by pressing shift key, there is File page menu. In the Menu, we can Select disk, copy file, load file, copy and paste file to other disk, delete file, clear up system disk and so on.

## 3.4.2 Build the Ethernet communication

Ethernet Interface is standard , by the interface we can build the communication between computer and controller DDCS V4.1.

### Step 1:

Make sure the SMB status is open on your computer, let' s take the example with Win 10 system:

1. Clিকে WIN button and -> Setting on your PC:

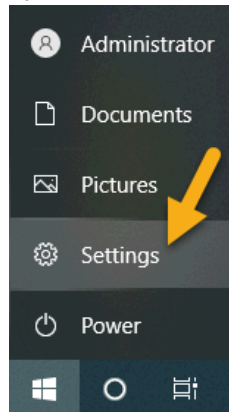

Figure 3-64 Click Setting

2. In the Setting page and Click “Apps”:

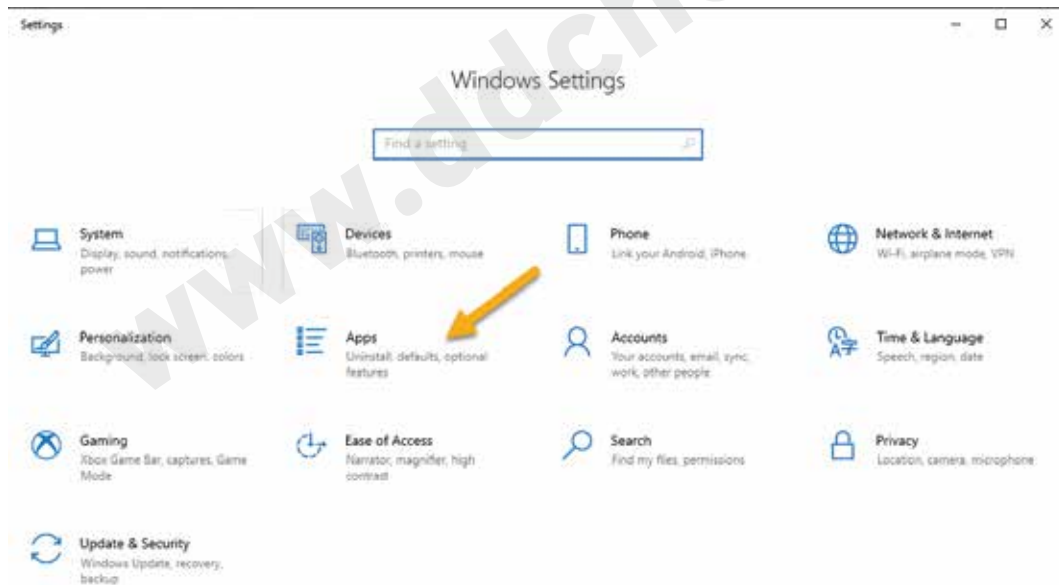

Figure 3-60 Setting -- Apps

3. In the new pop-up window click the “Programs and Features”:

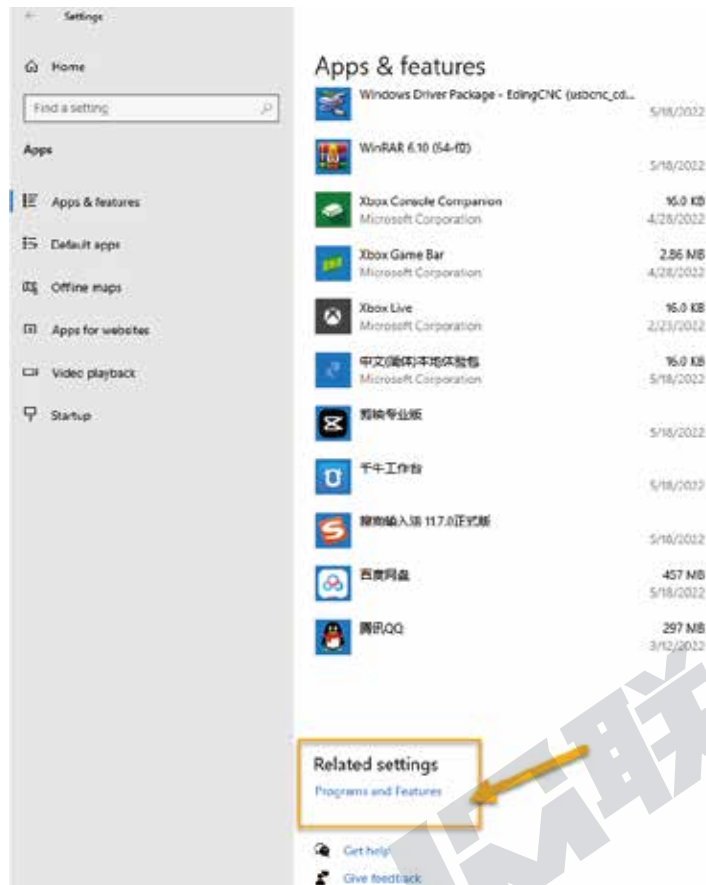

Figure 3-61 Apps & features -- Related settings

4. Click “Turn Windows features on or off” at the left side of the page:

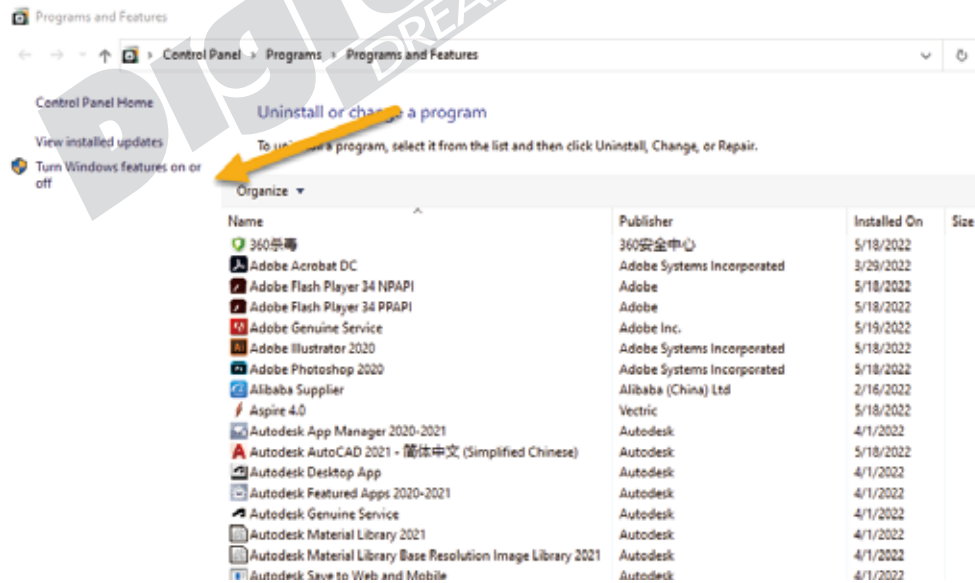

Figure 3-62 “Turn Windows features on or off”

5. Now we can find out there is the SMB options, tick all the SMB check box please:

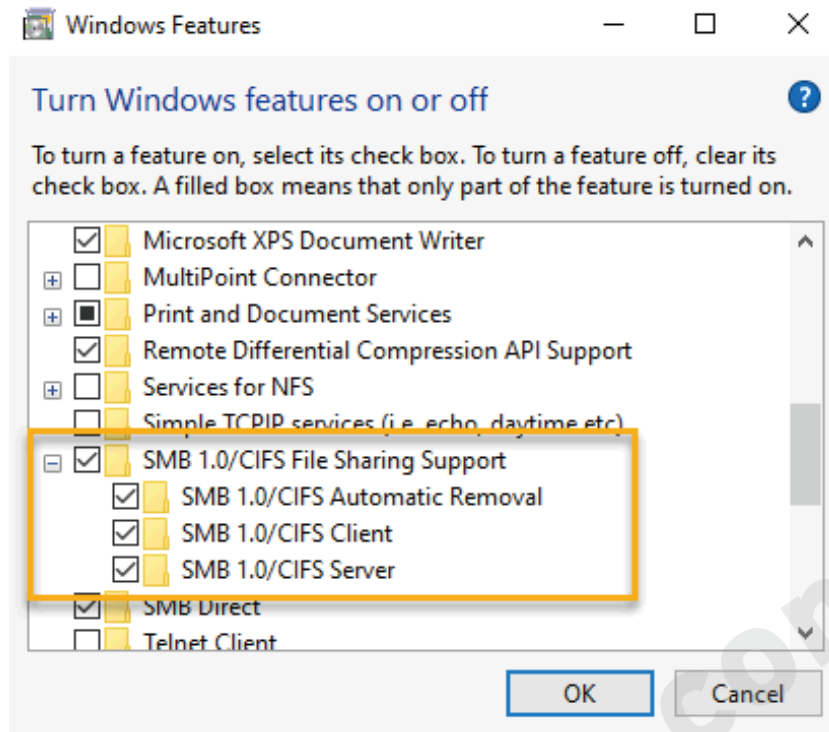

Figure 3-63 Turn the SMB options ON

Now the SMB options are ON and we go on next step.

**Step 2:**

Configure the Ethernet settings on the controller DDCS V4.1.

CONT	READY	/udisk-sda1/ball1.nc	+00:00:00	Guest
No.	Param. Name		Value	Unit
318	Tool path page display coordinates		Yes	
319	X axis rotation angle in 3D mode		0.0000	deg
320	Y axis rotation angle in 3D mode		0.0000	deg
321	Z axis rotation angle in 3D mode		0.0000	deg
322	Monitoring page disabled in machining		Yes	
323	Enable of beep		Enable	
324	Color reversal		No	
325	Disable network functionality		No	
326	Obtain IP address automatically		No	
327	Local IP address		192.168.2.5	
328	Net mask		255.255.255.0	
329	Router IP address		192.168.2.1	
330	Shared host IP address		192.168.2.8	
331	Time zone settings		0	
ParamType	Search	Visible	Export	Import
			Logout	Main...

Figure 3-64 Settings about the Ethercat Networks

“#325 -- disable network function”: Firstly We must enable the network function, or the controller don't work on the network at all. Enable it and then next step.

“#327 -- Local IP address”: We already set IP address for the controller DDCS V4.1 on our hands.

“#330 -- Shared host IP address”: #330 is to set the IP address for the computer.

The settings are done and we back to the main page and we can see the local IP address here:

CONT	READY	/udisk-sda1/ball1.nc	+00:00:00	Guest			
Axis	Mach	Abs	FRO:	100%			
⊙ X	10.000	10.000	SRO:	100%			
⊙ Y	10.000	10.000	JSR:	100%			
⊙ Z	10.000	0.000	F	0 3000			
			S	0 12000			
			G54 H00 M5 M9 M11				
			Software Ver: 2022-05-29-001-NOR				
			Local disk: \\192.168.2.5\ncdisk				
			ID:04-01050001-365196531ea215b6				
Start	Pause	Reset	View	MpgGuide	Spindle	File...	00:01:59 1970-01-01

Figure 3-65 IP address showed on the Main page

**Step 3:** Set the IP address for the computer.

1. Setting -- Network & Internet and will pop up the page as below:

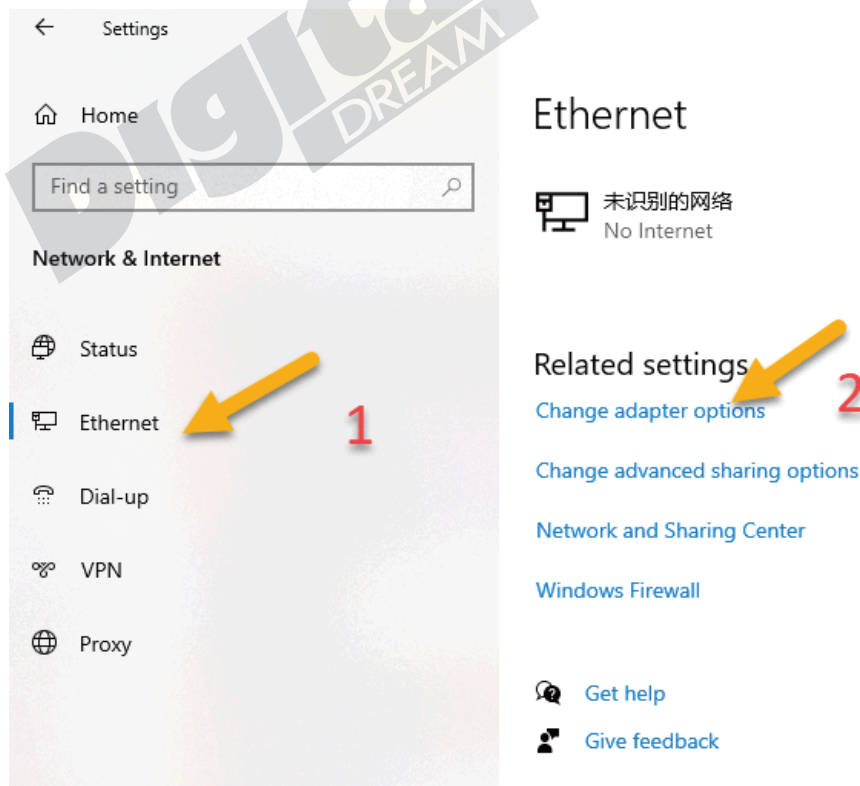

Figure 3-66 Ethernet Page at the Computer

2. Click “Ethernet” at the left page and click “change adapter options” at the right page, screen pops up a new window:



Figure 3-67 Ethernet set up

3. Left click the mouse on the Ethernet button and select “properties”, pop up the window to set up the IP address of the computer. At the Parameters of the controller, we already set the “#330 -- Shared host IP address” as “192.168.2.8”, here we must follow it:

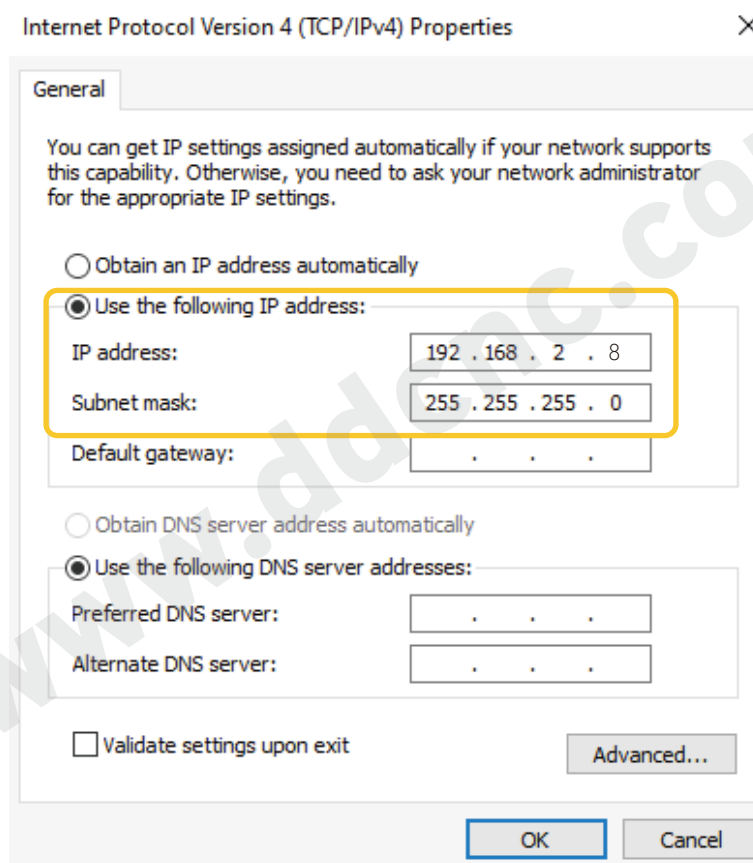

Figure 3-68 Ethernet set up

Please note that the IP address for the computer and the controller, the last number must be different. The last number range is “1-255”.

Now we already set up the communication between the computer and the controller DDCCS V4.1, we can visit the controller via our host computer.

On the computer in the address bar input “\\192.168.2.5\cncdisk” and Enter, the screen pops up a page as below, this is the local disk of the controller DDCCS V4.1.



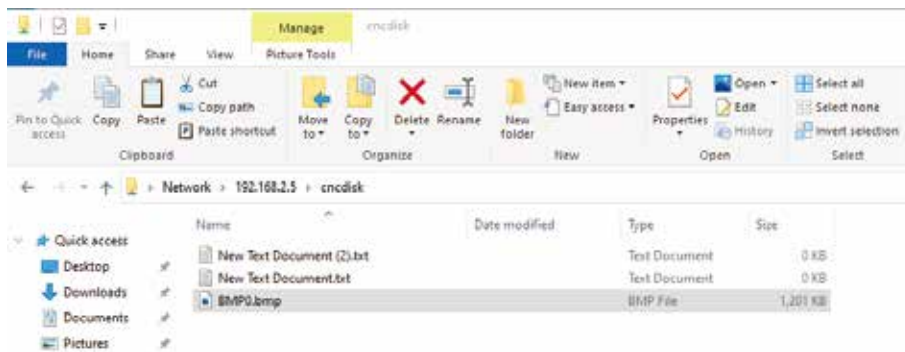

Figure 3-69 Local disk of the controller DDCS V4.1

Now, we can easily visit the local disk of the DDCS V4.1 on computer, and can we visit computer via controller DDCS V4.1? Yes!

**Step 4:** Create a folder of “share” on host computer and visit it via controller.

1. Change sharing the options for different network profiles.

Setting -- Network & Internet and will pop up the page as below:

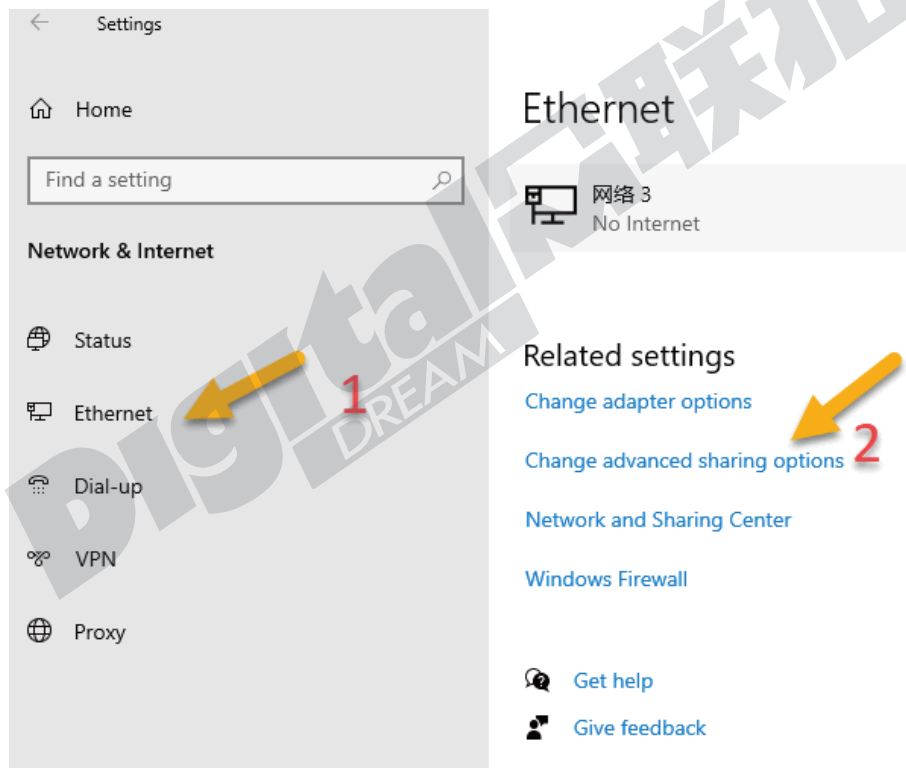

Figure 3-70 Ethernet Page at the Computer

2. Click “Ethernet” at the left page and click “change advanced sharing options” at the right page, screen pops up a new window:



### Change sharing options for different network profiles

Windows creates a separate network profile for each network you use. You can choose specific options for each profile.

#### Private

##### Network discovery

When network discovery is on, this computer can see other network computers and devices and is visible to other network computers.

- Turn on network discovery
  - Turn on automatic setup of network connected devices.
- Turn off network discovery

##### File and printer sharing

When file and printer sharing is on, files and printers that you have shared from this computer can be accessed by people on the network.

- Turn on file and printer sharing
- Turn off file and printer sharing

#### Guest or Public (current profile)

#### All Networks

Figure 3-71 Turn on the network discovery of the Private

### Change sharing options for different network profiles

Windows creates a separate network profile for each network you use. You can choose specific options for each profile.

#### Private

#### Guest or Public (current profile)

##### Network discovery

When network discovery is on, this computer can see other network computers and devices and is visible to other network computers.

- Turn on network discovery
- Turn off network discovery

##### File and printer sharing

When file and printer sharing is on, files and printers that you have shared from this computer can be accessed by people on the network.

- Turn on file and printer sharing
- Turn off file and printer sharing

#### All Networks

Figure 3-72 Turn on the network discovery of the Guest or Public

### Change sharing options for different network profiles

Windows creates a separate network profile for each network you use. You can choose specific options for each profile.

Private

Guest or Public (current profile)

All Networks

Public folder sharing

When Public folder sharing is on, people on the network, including homegroup members, can access files in the Public folders.

Turn on sharing so anyone with network access can read and write files in the Public folders  
 Turn off Public folder sharing (people logged on to this computer can still access these folders)

Media streaming

When media streaming is on, people and devices on the network can access pictures, music, and videos on this computer. This computer can also find media on the network.

[Choose media streaming options...](#)

File sharing connections

Windows uses 128-bit encryption to help protect file sharing connections. Some devices don't support 128-bit encryption and must use 40- or 56-bit encryption.

Use 128-bit encryption to help protect file sharing connections (recommended)  
 Enable file sharing for devices that use 40- or 56-bit encryption

Password protected sharing

When password protected sharing is on, only people who have a user account and password on this computer can access shared files, printers attached to this computer, and the Public folders. To give other people access, you must turn off password protected sharing.

Turn on password protected sharing  
 Turn off password protected sharing

Figure 3-73 For the Public folder sharing pls follow the setting above

2. Create a folder named it “share” on computer, right click the share folder and click “properties” , Click “Sharing” Option and click “Share...” button.

In the new pages, choose Everyone to share with; Choose the Permission level as “Read/Write”, and click “share”.

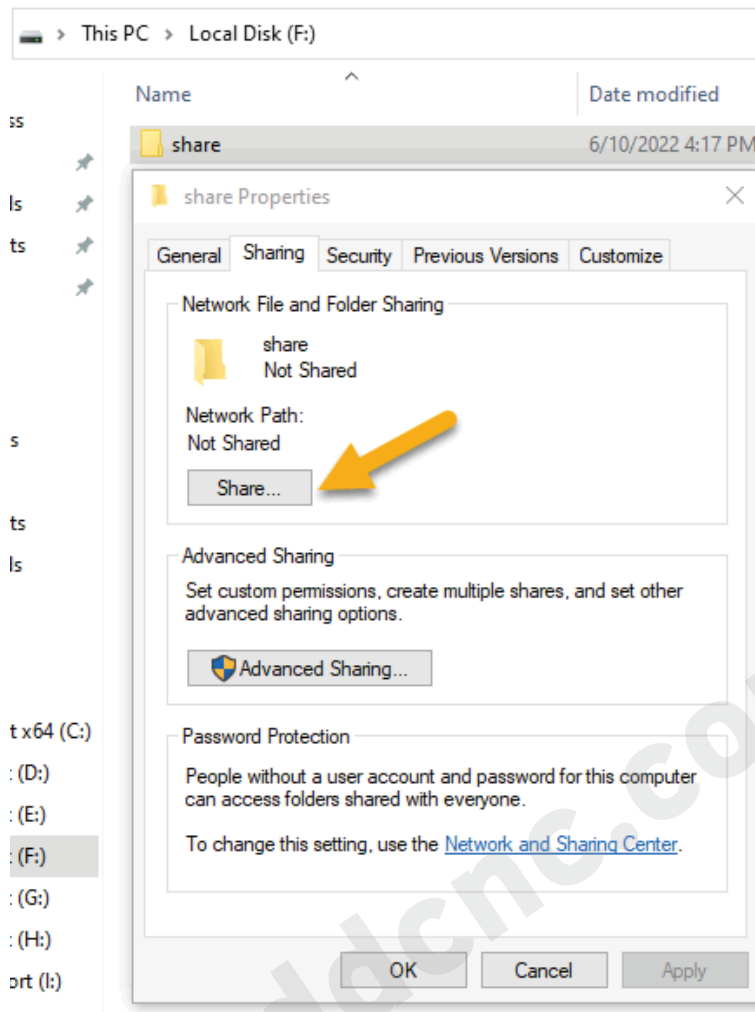

Figure 3-74 share properties

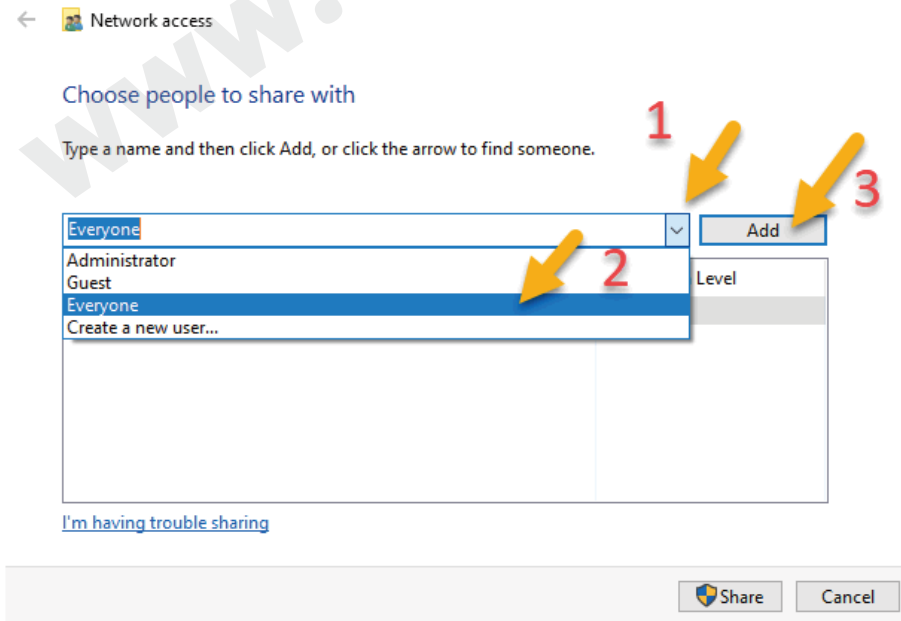

Figure 3-75 Choose Everyone to share with

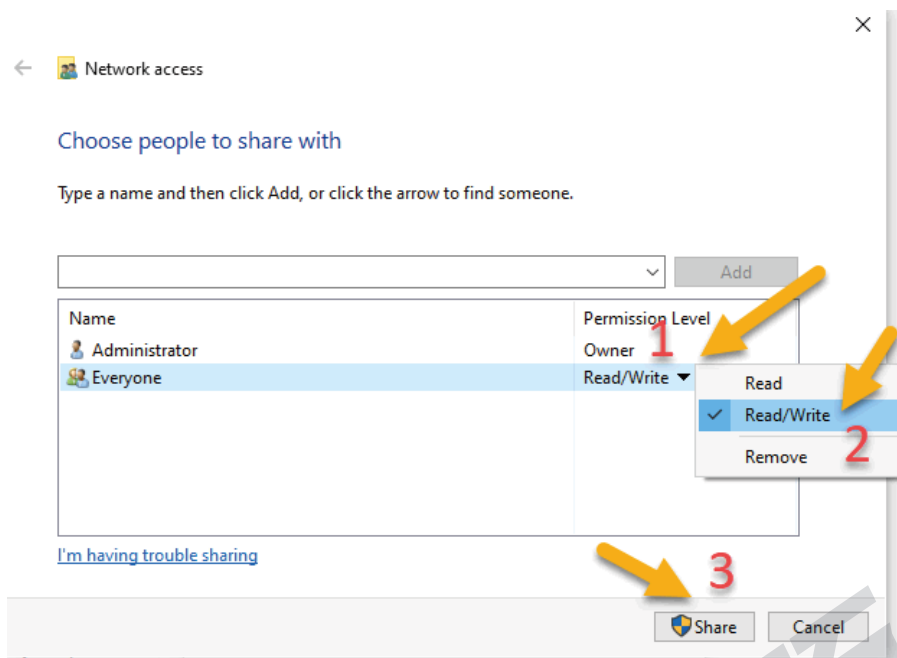

Figure 3-76 Choose the Permission level as "Read/Write"

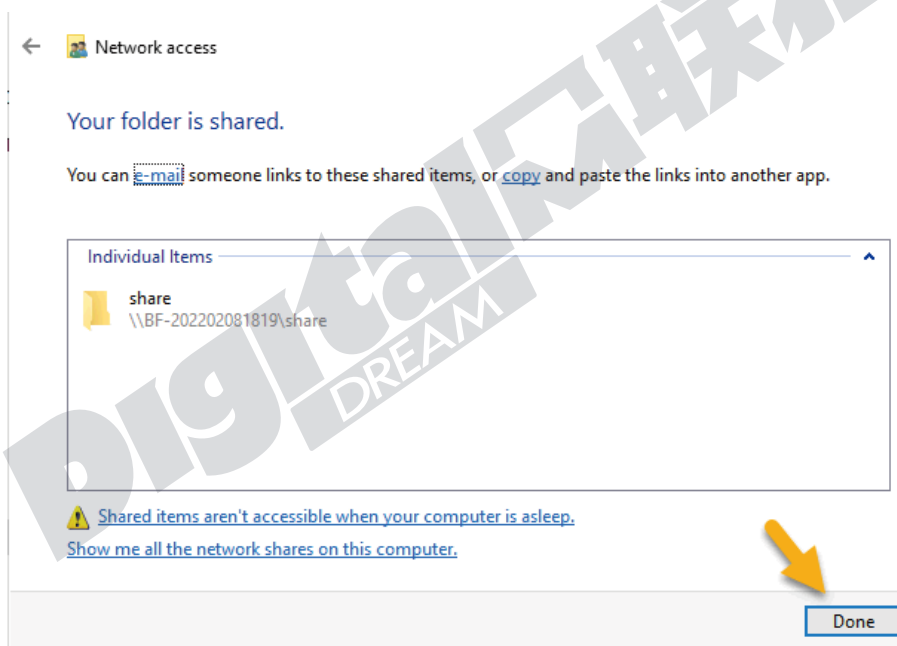

Figure 3-77 Sharing setting is completed

The sharing setting for the "share" folder is finished, and now we take our controller DDCCS V4.1, go to file page, and select "Net Disk", check what's in.

CONT	READY	/udisk-sda1/ball1.nc	+00:00:00	Guest
Name	Size	Modify time		
..	[DIR]	1935/05/01 08:58		
2002.nc	4146786	2022/04/26 02:17		
CARTRAGE 24MM 12000RPM F1050 6159193		2021/05/25 09:16		LocalDisk
NEWBALL.nc	2485039	2020/05/24 02:20		
ball1.nc	1653221	1979/12/31 16:00		
butterfly.nc	1299506	1979/12/31 16:00		
dbc-b.NC	142599753	2022/04/29 01:15		U-Disk
fish.nc	1830415	2021/11/24 09:18		
rl.nc	60087004	2022/04/29 01:14		
testtiny.nc	47018148	2022/05/01 13:24		
				NetDisk
				Free space: 488269MB 00:01:31 1970-01-01
Emulation	Copy	Edit	New	Delete
Rename	Param...			

Figure 3-78 The files in the Net Disk of the controller

> This PC > Local Disk (F:) > share

Name	Date modified	Type	Size
2002.nc	4/26/2022 10:17 AM	NC File	4,050 KB
ball1.nc		NC File	1,615 KB
butterfly.nc		NC File	1,270 KB
CARTRAGE 24MM 12000RPM F1050 6MM...	5/25/2021 5:16 PM	NC File	156 KB
dbc-b.NC	4/29/2022 9:15 AM	NC File	139,258 KB
fish.nc	11/24/2021 5:18 PM	NC File	1,788 KB
NEWBALL.nc	5/24/2020 10:20 AM	NC File	2,427 KB
rl.nc	4/29/2022 9:14 AM	NC File	58,679 KB
testtiny.nc	5/1/2022 9:24 PM	NC File	45,917 KB

Figure 3-79 The files in the "share" folder of the computer

### 3.4.3 Software Update

According to the customer feedback, we will endeavour to update the software in DDCS V4.1 , to enhance the performance, fix the bugs or add new features. In order for customer to download the latest firmware, please visit our website :

www.ddcnc.com

or our Facebook Forum:

[https://www.facebook.com/groups/1724999967517167/?ref=group\\_header](https://www.facebook.com/groups/1724999967517167/?ref=group_header) or join our forum

<http://bbs.ddcnc.com/forum.php>

There you can find the latest version firmware for DDCS. At the Left-bottom side of the Main-Page,there is the firmware version as the Figure 3-80:

CONT	READY	/ddcsv4/macroMillCylinder.nc	+00:00:17	Admin
Axis	Mach	Abs	FRO:	100%
⊙ X	10.000	0.000	SRO:	100%
⊙ Y	10.000	0.000	JSR:	100%
⊙ Z	10.000	0.000	F	0 3000
⊙ A	10.000	0.000	S	0 12000
92 N14G91G1A360				
G54 H00 M5 M9 M11				
Software Ver: 2022-05-29-001-NOR				
Local disk:\192.168.2.5\cncdisk				
ID:04-01050001-3651964b91a215b6				
Start	Pause	Reset	View	MpgGuide Spindle File... 21:36:18 1912-02-27

Figure 3-80 The software Version No.

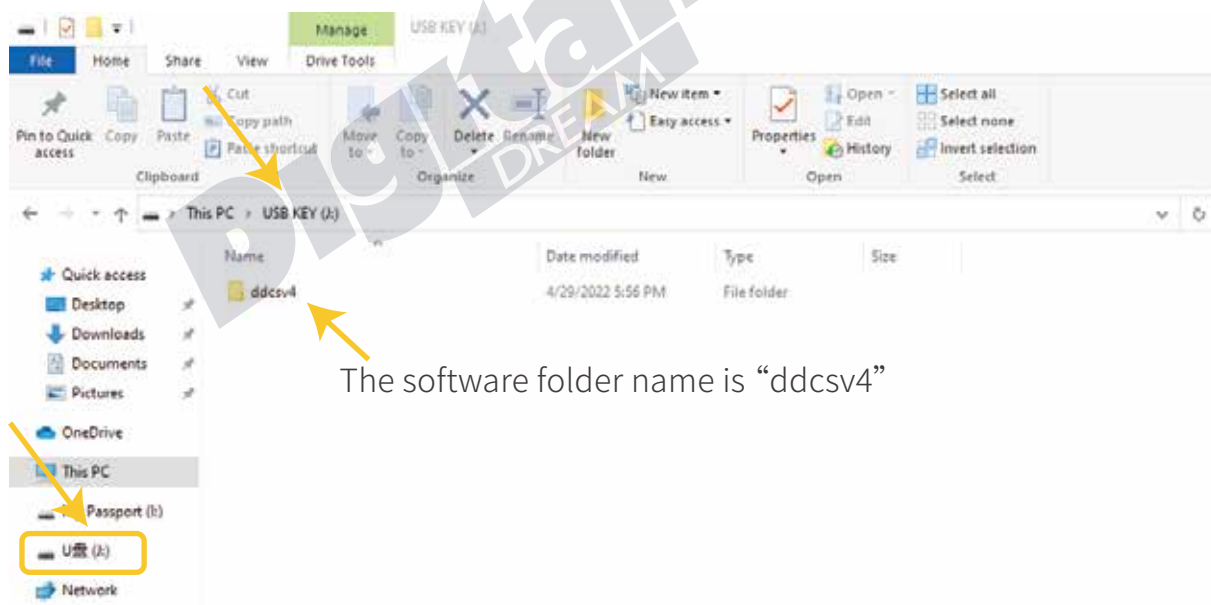

Figure 3-81 Position of the software folder

The DDCS V4.1 software install folder name is not “INSTALL”, it is “ddcsv4”, its very important please pay attention to.

Download the firmware upgrade file to your computer and prepare a totally empty USB key. Best is to quickly reformat the USB key to MS-DOS FAT32 (right click on the USB key icon and choose Format. Follow the prompts)

After downloading the firmware file check the file name, it may look like this or similar install(2022-05-29)-zip . (example)

This is done to allow the download. Files called “.ZIP” are sometimes blocked.

Change the file name to install(2019-08-16-112).zip (example)

Now your zip program can recognise the file as a compressed file and you can decompress it to the USB key. Please note the upgraded file should be in the Root-directory in the USB Stick and the file name must be “ddcsv4”.

Now your USB key is ready for action.

Shut down your DDCS controller for 10 seconds. Insert the USB key into the USB port of your DDCS controller .

Start your DDCS controller. The controller will read the “ddcsv4” folder on the USB key and upgrade automatically. The screen will be blocked for about 30 seconds, then the controller will start with the new firmware.

On the Main Screen lower right you can see the firmware version the controller is using.

After upgrading successfully, don't forget to remove the Install folder from the USB key. If you do not remove the “ddcsv4” folder the controller will update again next time you start the controller.

www.ddcnc.com

USB KEY (J:) > ddcsv4

Name	Date modified	Type	Size
adjush.nc	4/11/2022 7:58 AM	NC File	1 KB
adjush.rc	4/11/2022 7:58 AM	RC File	8 KB
advstart.nc	4/11/2022 7:58 AM	NC File	1 KB
advstart.rc	4/11/2022 7:58 AM	RC File	14 KB
advstart-array.rc	4/11/2022 7:58 AM	RC File	17 KB
advstart-sr.rc	4/11/2022 7:58 AM	RC File	15 KB
array.nc	4/11/2022 7:58 AM	NC File	1 KB
array.rc	4/11/2022 7:58 AM	RC File	19 KB
break.rc	4/11/2022 7:58 AM	RC File	14 KB
break-array.rc	4/11/2022 7:58 AM	RC File	17 KB
break-sr.rc	4/11/2022 7:58 AM	RC File	15 KB
center.rc	4/11/2022 7:58 AM	RC File	8 KB
centerx.nc	4/11/2022 7:58 AM	NC File	1 KB
centery.nc	4/11/2022 7:58 AM	NC File	1 KB
chs	4/11/2022 7:58 AM	File	27 KB
coord1	4/11/2022 7:58 AM	File	1 KB
custom	4/11/2022 7:58 AM	File	27 KB
ddcsv4.out	4/11/2022 7:58 AM	OUT File	4,815 KB
end.nc	4/11/2022 7:58 AM	NC File	1 KB
eng	4/11/2022 7:58 AM	File	27 KB
error.nc	4/11/2022 7:58 AM	NC File	1 KB
gotoz.nc	4/11/2022 7:58 AM	NC File	1 KB
gotozxy.nc	4/11/2022 7:58 AM	NC File	1 KB
home_0.nc	4/11/2022 7:58 AM	NC File	1 KB
home_1.nc	4/11/2022 7:58 AM	NC File	1 KB
home_2.nc	4/11/2022 7:58 AM	NC File	1 KB
home_3.nc	4/11/2022 7:58 AM	NC File	1 KB
home_4.nc	4/11/2022 7:58 AM	NC File	1 KB
home_ref1.nc	4/11/2022 7:58 AM	NC File	1 KB
home_ref2.nc	4/11/2022 7:58 AM	NC File	1 KB
home_ref3.nc	4/11/2022 7:58 AM	NC File	1 KB
home_ref4.nc	4/11/2022 7:58 AM	NC File	1 KB
loadbreak.nc	4/11/2022 7:58 AM	NC File	1 KB
logo.bmp	4/11/2022 7:58 AM	BMP File	1,801 KB
M3.nc	4/11/2022 7:58 AM	NC File	1 KB
M4.nc	4/11/2022 7:58 AM	NC File	1 KB
M5.nc	4/11/2022 7:58 AM	NC File	1 KB
M6.rc	4/11/2022 7:58 AM	RC File	18 KB
m30.nc	4/11/2022 7:58 AM	NC File	0 KB
macroMillCylinder.nc	4/11/2022 7:58 AM	NC File	2 KB
macroMillCylinder.rc	4/11/2022 7:58 AM	RC File	21 KB
macroMillRect.nc	4/11/2022 7:58 AM	NC File	2 KB
macroMillRect.rc	4/11/2022 7:58 AM	RC File	24 KB
motiondev.ko	4/11/2022 7:58 AM	KO File	14 KB
msg-chs	4/11/2022 7:58 AM	File	17 KB
msg-custom	4/11/2022 7:58 AM	File	17 KB
msg-eng	4/11/2022 7:58 AM	File	17 KB
null.nc	4/11/2022 7:58 AM	NC File	1 KB
pause.nc	4/11/2022 7:58 AM	NC File	1 KB
probe-fix.nc	4/11/2022 7:58 AM	NC File	1 KB
probe-fix.rc	4/11/2022 7:58 AM	RC File	19 KB
probe-float.nc	4/11/2022 7:58 AM	NC File	1 KB

Figure 3-82 The files a “ddcsv4” folder included



File Name	File description
array...	Array -- Executable file
break...	Breakpoint -- Executable file
center...	Find Middle -- Executable file
chs	Parameters File in Chinese
eng	Parameters File in English
custom	Parameters file in custom language.
ddcsv4.out	System program file
error.nc	When work in error, system execute this file, Prohibit to modify it.
goto...	Go to Zero Executable File
home...	Home Executable File
loadbreak.nc	Load Breakpoint Executable File
logo.bmp	Open Page LOGO file, size is 1024p x 600 px, 72px/inch. The users can customize their own open page.
macroMillCylinder.nc	Milling Cylinder Machining File
macroMillRect.nc	Milling plane processing file
motiondev.ko	.ko file is a hard drive, Modification is prohibited.
M3/M4/M5	Manual M-code execution file
msg-chs	Chinese interface character display configuration
msg-eng	English interface character display configuration
msg-custom	Interface character display configuration in custom language.
pause.nc	Executable file for Pause
probe...	Executable file for Probe
simulate...	Executable file for Simulation
slib-g.nc	System library file
slib-m.nc	The users self-define M code library file.
zero...	Executable file for Zero
setting	Parameters setting file



Figure 3-83 Setting for Open Page

## 3.5 Parameters Management Page

In the Parameters Management Page, beside the parameters adjustment, we can search the parameter by numbers, configurate invisible parameters, export setting file, import settings, login, set the password and so on.

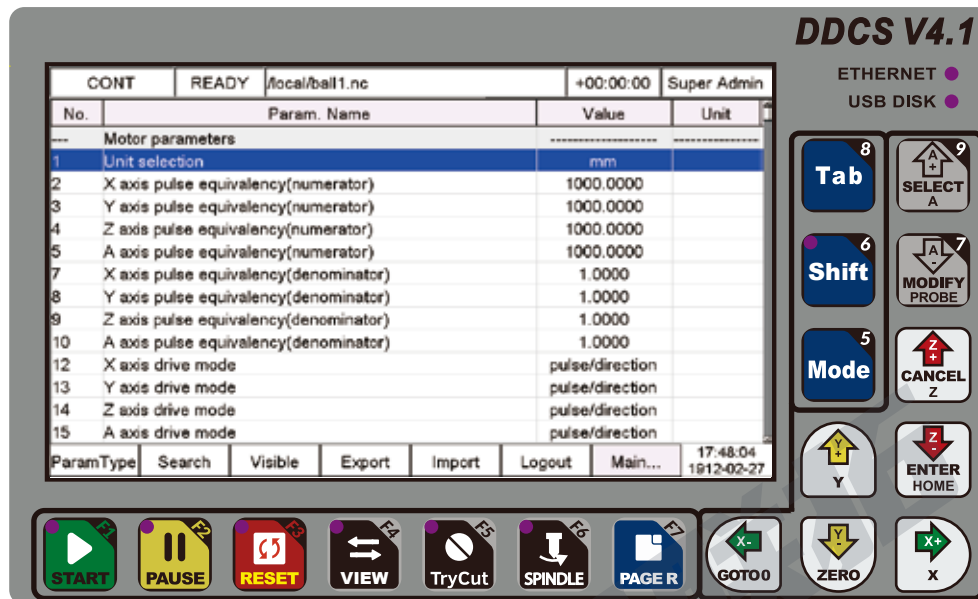

Figure 3-84 Parameters Management Page

### Parameters type:

Press F1 pop up parameter type table, by Y+/Y- keys we can select the type that we need and Press Enter key to jump to.

There are 16 kinds parameters type: 1) Motor parameters; 2) Manual control parameters; 3) Automatic control parameters; 4) Output signal parameters; 5) Input signal parameters; 6) Spindle parameters; 7) M output code parameters; 8) Home parameters; 9) Probe parameters; 10) Vertex probe parameters; 11) Software limit parameters; 12) MPG parameters; 13) External key parameters; 14) Backlash parameters; 15) Tool offsets; 16) System settings

### Search the Parameters:

Press Key F2 it pops up a dialog asking for number input. With X+/X- key, move the cursor, with Y+/Y- key increase or decrease the current position number. Meanwhile, the number key is active, we also can input the numbers directly. Press Enter key the system just search out the parameter.

### Visible:

Under super administrator rights, select a parameter and Press F3 key, then the background for the parameter turns to dark. Then the guest, operator or administrator cannot see this parameter, it is invisible. Only the super administrator can see it in the dark background. If the users want to make the invisible parameters to visible, login in as super administrator, select the visible parameter, press F3 again.

CONT	READY	/local/ball1.nc	+00:00:00	Super Admin
No.	Param. Name	Value	Unit	
System settings				
312	language setting	Eng		
313	Shift key operation mode	Menu Mode		
316	Tool path paint enable	Disable		
317	Tool path paint mode	Statue Mode		
318	Tool path page display coordinates	Yes		
319	X axis rotation angle in 3D mode	0.0000	deg	
320	Y axis rotation angle in 3D mode	0.0000	deg	
321	Z axis rotation angle in 3D mode	0.0000	deg	
322	Monitoring page disabled in machining	Yes		
323	Enable of beep	Enable		
324	Color reversal	No		
325	Disable network functionality	Yes		
326	Obtain IP address automatically	No		
327	Local IP address	192.168.2.5		
ParamType	Search	Visible	Export	Import
	Logout	Main...		
				17:49:27 1912-02-27

Figure 3-85 As Super Admin, we make language setting visible

CONT	READY	/local/ball1.nc	+00:00:00	Guest
No.	Param. Name	Value	Unit	
System settings				
313	Shift key operation mode	Menu Mode		
316	Tool path paint enable	Disable		
317	Tool path paint mode	Statue Mode		
318	Tool path page display coordinates	Yes		
319	X axis rotation angle in 3D mode	0.0000	deg	
320	Y axis rotation angle in 3D mode	0.0000	deg	
321	Z axis rotation angle in 3D mode	0.0000	deg	
322	Monitoring page disabled in machining	Yes		
323	Enable of beep	Enable		
324	Color reversal	No		
325	Disable network functionality	Yes		
326	Obtain IP address automatically	No		
327	Local IP address	192.168.2.5		
ParamType	Search	Visible	Export	Import
	Logout	Main...		
				17:50:06 1912-02-27

Figure 3-86 As Guest, the language setting is invisible

### Export (F4) and Import (F5) Parameters

All the parameters setting information, is saved in the file named “setting” in the system software. Export is to copy the setting file from controller system to root directory of USB stick; Import is to copy the setting file from root directory of USB stick to control system.

CONT	READY	/local/ball1.nc	+00:00:00	Super Admin
No.	Param. Name	Value	Unit	
Motor parameters				
1	Unit selection	mm		
2	X axis	8888.8888		
3	Y axis			
4	Z axis			
5	A axis			
7	X axis			
8	Y axis			
9	Z axis			
10	A axis			
12	X axis drive mode	pulse/direction		
13	Y axis drive mode	pulse/direction		
14	Z axis drive mode	pulse/direction		
15	A axis drive mode	pulse/direction		
ParamType	Search	Visible	Export	Import
	Logout	Main...		
				17:50:48 1912-02-27

Figure 3-86 Backup Parameter setting to USB Stick

CONT	READY	/local/ball1.nc	+00:00:00	Super Admin
No.	Param. Name	Value	Unit	
Motor parameters				
1	Unit selection	mm		
2	X axis	8888.8888		
3	Y axis			
4	Z axis			
5	A axis			
7	X axis			
8	Y axis			
9	Z axis			
10	A axis			
12	X axis drive mode	pulse/direction		
13	Y axis drive mode	pulse/direction		
14	Z axis drive mode	pulse/direction		
15	A axis drive mode	pulse/direction		
ParamType	Search	Visible	Export	Import
	Logout	Main...		
				17:50:57 1912-02-27

Figure 3-87 Recovery parameter setting from USB Stick

When the Shift key operation mode is Menu mode, Press Shift key to call out the Parameter page menu. The Sub-menus are: 1) User Login; 2) Password setting; 3) Parameters backup; 4) Parameter recovery.

Users Login: The users can login in as Operator, Administrator, Super Administrator;

The initial password of the super administrator is 888888. DDCS V4.1 password judgment is a numerical judgment, as operator and super administrator, password is 0 or don't input anything, the effect is the same.

Password setting: We can set the password for operator, administrator and super administrator.

Parameter Backup: Here we can backup the setting file to USB stick, system disk or the Net disk, when the ethernet communication is built up.

Parameter Recovery: We can recovery the settings from USB stick, system disk or the Net disk, when the ethernet communication is built up.

# 4 Parameter Instruction

## 1. Motor Parameters

Para#	Parameter Definition	Default	Range	Unit
#001	Unit selection	0: mm	0: mm, 1: inch	
#002	X axis pulse equivalency(numerator)	1000.0000	4.0.000 ~ 99999.999	
#003	Y axis pulse equivalency(numerator)	1000.0000	0.000 ~ 99999.999	
#004	Z axis pulse equivalency(numerator)	1000.0000	0.000 ~ 99999.999	
#005	A axis pulse equivalency(numerator)	1000.0000	0.000 ~ 99999.999	
#007	X axis pulse equivalency(denominator)	1.0000	1.000 ~ 99999.999	
#008	Y axis pulse equivalency(denominator)	1.0000	1.000 ~ 99999.999	
#009	Z axis pulse equivalency(denominator)	1.0000	1.000 ~ 99999.999	
#010	A axis pulse equivalency(denominator)	1.0000	1.000 ~ 99999.999	
#012	X axis drive mode	pulse/direction	0: pulse/direction, 1: Two-pulse	
#013	Y axis drive mode	pulse/direction	0: pulse/direction, 1: Two-pulse	
#014	Z axis drive mode	pulse/direction	0: pulse/direction, 1: Two-pulse	
#015	A axis drive mode	pulse/direction	0: pulse/direction, 1: Two-pulse	
#017	Direction-pulse time interval(pulse/direction)	7000	0.000 ~ 9999.000	
#018	X axis motion direction(pulse/direction mode)	Positive	0: Negative, 1: Positive	
#019	Y axis motion direction(pulse/direction mode)	Positive	0: Negative, 1: Positive	
#020	Z axis motion direction(pulse/direction mode)	Positive	0: Negative, 1: Positive	
#021	A axis motion direction(pulse/direction mode)	Positive	0: Negative, 1: Positive	
#023	X axis pulse signal level(pulse/direction mode)	Low	0: low, 1: high	
#024	Y axis pulse signal level(pulse/direction mode)	Low	0: low, 1: high	
#025	Z axis pulse signal level(pulse/direction mode)	Low	0: low, 1: high	
#026	A axis pulse signal level(pulse/direction mode)	Low	0: low, 1: high	
#028	X axis motion direction(two-pulse mode)	Positive	0: Negative, 1: Positive	
#029	Y axis motion direction(two-pulse mode)	Positive	0: Negative, 1: Positive	
#030	Z axis motion direction(two-pulse mode)	Positive	0: Negative, 1: Positive	
#031	A axis motion direction(two-pulse mode)	Positive	0: Negative, 1: Positive	
#033	Enable axis mapping function	No	0: No 1: Yes	
#034	Master axis selection	X axis	0: X, 1: Y, 2: Z, 3: A	
#035	Slave axis selection	Y axis	0: X, 1: Y, 2: Z, 3: A	
#036	Enable A axis cyclic encoding	No	0: No 1: Yes	
#037	A axis cyclic encoder upper	180.0000	-9999.000 ~ 9999.000	Unit
#038	A axis cyclic encoder lower	-180.0000	-9999.000 ~ 9999.000	Unit
#039	AB axis Selection	A axis	0: A axis, 1: B axis	

#001: DDCS V4.1 adopts two kinds length units, metric system and imperial system respectively, and both directly participate in the internal algorithm of the control system. Be careful all the parameter settings in this system, pay attention they are based on the metric system or the inch system.

#002~#010: Numerator: The number of pulses required for one revolution in one direction; Denominator: The feeding distance the motor moves one revolution in one direction. The pulse equivalent = numerator /denominator

#017 has the same function as parameter #416 in DDCS V3.1. After years experience and debugging,7000 is a suitable value for stepper system. ; but in the case of losing step, if exclude any other causes and still cannot find out where the problem from, you can try to debug this parameter.

#023~#026: The setting of the input pulse to driver has two kind, falling edge or rising edge. If the setting doesn't match with controller parameter, then each first input pulse the controller send will be missed by driver. When the axis changes direction frequently, the accumulated error will get bigger and bigger.

#033~#035: This parameter can be used to set the master axis and the slave axis. The slave axis simply follows the master axis to move, and runs the same code as the master axis. It is not an independent axis, and limit switches cannot be used. The master axis is an independent axis and can use limit switches.

#036~#038: For the G code of the A axis is always increasing, the cyclic encoder can be turned on, so that the actual displayed value is between the upper limit and the lower limit. For example, the upper limit is 360 and the lower limit is 0. If the command is 361°, the actual operation is to run 1°.

## 2. Manual Control Parameters

Para#	Parameter Definition	Default	Range	Unit
#040	Motor start speed	50.0000	0.000 ~ 999.000	unit/min
#041	X axis manual control speed	5000.0000	1.000 ~ 99999.000	unit/min
#042	Y axis manual control speed	5000.0000	1.000 ~ 99999.000	unit/min
#043	Z axis manual control speed	5000.0000	1.000 ~ 99999.000	unit/min
#044	A axis manual control speed	5000.0000	1.000 ~ 99999.000	Degree/min
#046	X axis start Acc in M_Ctrl mode	300.0000	0.3 ~ 9999.000	unit/s <sup>2</sup>
#047	Y axis start Acc in M_Ctrl mode	300.0000	0.3 ~ 9999.000	unit/s <sup>2</sup>
#048	Z axis start Acc in M_Ctrl mode	300.0000	0.3 ~ 9999.000	unit/s <sup>2</sup>
#049	A axis start Acc in M_Ctrl mode	300.0000	0.3 ~ 9999.000	Degree/s <sup>2</sup>
#051	X axis stop Acc in M_Ctrl mode	600.0000	0.3 ~ 9999.000	unit/s <sup>2</sup>
#052	Y axis stop Acc in M_Ctrl mode	600.0000	0.3 ~ 9999.000	unit/s <sup>2</sup>
#053	Z axis stop Acc in M_Ctrl mode	600.0000	0.3 ~ 9999.000	unit/s <sup>2</sup>
#054	A axis stop Acc in M_Ctrl mode	600.0000	0.3 ~ 9999.000	Degree/s <sup>2</sup>
#056	X axis emergency stopAcc in M_Ctrl mode	1600.0000	0.3 ~ 9999.000	unit/s <sup>2</sup>
#057	Y axis emergency stopAcc in M_Ctrl mode	1600.0000	0.3 ~ 9999.000	unit/s <sup>2</sup>
#058	Z axis emergency stopAcc in M_Ctrl mode	1600.0000	0.3 ~ 9999.000	unit/s <sup>2</sup>
#059	A axis emergency stopAcc in M_Ctrl mode	1600.0000	0.3 ~ 9999.000	Degree/s <sup>2</sup>
#091	X Axis max speed in M_Ctrl mode	12000.0000	99.000 ~ 99999.000	unit/min
#092	Y Axis max speed in M_Ctrl mode	12000.0000	99.000 ~ 99999.000	unit/min
#093	Z Axis max speed in M_Ctrl mode	12000.0000	99.000 ~ 99999.000	unit/min
#094	A Axis max speed in M_Ctrl mode	12000.0000	99.000 ~ 99999.000	unit/min
#096	Jog support in CONT mode	Yes	0: No, 1:Yes	unit
#097	Jog moving distance in CONT mode	1.0000	0.000 ~ 999.000	unit
#098	Jog-1 moving distance	5.0000	0.000 ~ 999.000	unit
#099	Jog-2 moving distance	1.0000	0.000 ~ 999.000	unit
#100	Jog-3 moving distance	10.0000	0.000 ~ 999.000	unit

A) The FRO override range is 0~300%, However the real feed speed may be too high for the machine, so we use #41-44- to set a limited speed for safety reason.

B) Please note that the Max. speed cannot be set as Manual control speed. In the controller system we designed the algorithm for the speed plan based on the manual control speed, if the max. speed is smaller than manual control speed, will disturb the algorithm plan.

C) DDCS V4.1 supports Asymmetric Acc/Dec speed. But when the MPG is in Precision control mode, the controller will execute each pulse the MPG made, in this situation controller don't support Asymmetric Acc/Dec speed mode, when stop the system the system also cites the Start Acc Speed.

D) In the mode of STEP, Start&Stop Acc/Dec speed both cites the start acc speed.

### 3. Automatic control Parameters

Para#	Parameter Definition	Default	Range
#101	Speed Selection	1:default speed	0: set by G code, 1: use default speed
#102	default operation speed	3000.0000	min=1.000 -max=99999.000 unit/min
#103	G0 Speed	3000.0000	min=1.000 -max=99999.000
#104	operation acceleration	500.0000	min=0.3 -max=9999.000 unit/s <sup>2</sup>
#105	Speed drop rate during pause	5.0000	min=1 -max=99.000
#106	Speed drop rate during Estop	20.0000	min=1 -max=99.000
#107	Uniaxial acc is limited by M_Ctrl start acc	No	0: No; 1: Yes
#108	Restore the machining start point position (when #36=No)	Pause position	0: Pause line start; 1: Pause position
#109	Machining accuracy	0.0020	min=0.000 -max=0.1
#110	arc algorithm chord error	0.0010	min=0.001 -max=0.1
#111	Circular centrifugal acceleration	0.0000	min=0.000 -max=9999.000
#112	Circular speed adjustment factor	1.0000	min=0.1 -max=2.0
#113	maximum speed	8000.0000	min=99.000 -max=99999.000
#114	X axis protection speed	99999.0000	min=1.000 -max=99999.000 unit/min
#115	Y axis protection speed	99999.0000	min=1.000 -max=99999.000
#116	Z axis protection speed	3000.0000	min=1.000 -max=99999.000 unit/min
#117	A axis protection speed	99999.0000	min=1.000 -max=99999.000
#119	Z axis dropping protection speed	3000.0000	min=1.000 -max=99999.000 unit/min
#120	G0 instruction movement mode	Interpolation	0: Independent; 1:Interpolation
#121	Is FRO valid for G0?(when #120=Interpolation)	Yes	0: No; 1: Yes
#122	Macro programming mode	Disable	0: Disable; 1: Enable
#123	Macro program file main program No.	0	min=0.000 -max=9999.000
#124	Interpolation period	0.0050	min=0.002 -max=0.010
#125	Bias coordinate adjustment step	1.0000	min=0.000 -max=1.000 unit
#126	Bias coordinate adjustment speed	500.0000	min=1.000 -max=99999.000
#900	Z axis return to machine safe height when starting machining	Yes	0: No; 1: Yes
#901	Z axis return to machine safe height when restore machining	Yes	0: No; 1: Yes
#902	Z axis machine safe height	5.0000	min=-9999.000 -max=9999.000 unit
#903	Pause action selection	Z-axis lift	0: Z-axis lift; 1:Reference point 1
#904	Z axis lift distance when pause	5.0000	min=0.000 -max=999.000 unit
#905	Tool change command M6 back to reference point 1 pause	No	0: No; 1: Yes
#906	Z axis positioning when goto zero	Workpiece safe height	0: Workpiece safe height; 1: Machine safe height
#907	Z axis Workpiece safe height	0.0000	min=-9999.000 -max=9999.000

#104: Tangential Velocity is Compound Velocity

#105-#106: The buffer space is added for pause and emergency stop. It' s the acceleration for pause and emergency stop;

#107: For axial speed protection, in auto mode, the acceleration is only set by one parameter #104. However, due to the different mechanical conditions of XYZA axis, only one acceleration cannot be guaranteed to be suitable for all axes. Then create the parameter #107 to control the acceleration speed for each axis is limited by Start Acc In M\_Ctrl Mode or not; When #107=1, if the X Start Acc in M\_Ctrl Mode is small then Acceleration which Operation Acceleration (#104) projected onto the X axis, the system will cite the Start Acc In M\_Ctrl Mode of X axis.

#109-#110: Machining accuracy and arc algorithm chord error are with similar concepts, that is, after re-planning the contour, the maximum distance between the theoretical contour and the planned contour.

#111: Circular centrifugal acceleration is Tangential speed: In the case of small radius, the speed can be effectively limited and to avoid too high rotation speed due to too small radius.

#112: Since there is only one value an F value to control the speed in G-code, many users need to reset the speed when run the arc, so they can use the Circular speed adjustment factor, arc speed = F \* # 125.

#113: In the auto mode, we can adjusted FRO to 300%. If the speed is too high, it may not match the machine structure. #113 is limited for this situation;

#114~#117: In Auto Mode,the feed speed is set by F value. System will calculate out a projection speed on X/Y/Z/A axis seperately by F value.The control system will cite a slower speed between the protection speed and projection speed on each axis.

#122: When the system needs to analyze a subprogram, this parameter must be enabled, otherwise the subprogram will be invalid.

#124: The shorter the interpolation period, the shorter and finer the small line segment will be, the smoother the processing will be, but the processing time will be longer, and the more system memory will be consumed at the same time; the larger of the setting, the shorter the processing time, but the rush on the machine It will be strong, and it is recommended to use the default value.

#905: This parameter is helpful for manual tool change. When encountering program M6, the machine will return to reference point 1 and pause, and the user can start manual tool change.

## 4. Output signal Parameters

Para#	Parameter Definition	Default	Range
#127	M3 Output Port CW Rotation	1	0 ~ 3
#128	M4 Output Port CCW Rotation	0	0 ~ 3
#129	M8 Output Port	2	0 ~ 3
#130	M10 Output Port	3	0 ~ 3
#131	M3 active electric level	High	0: Low; 1: High
#132	M4 active electric level	High	0: Low; 1: High
#133	M8 active electric level	High	0: Low; 1: High
#134	M10 active electric level	High	0: Low; 1: High



## 5. Input signal Parameters

Para#	Parameter Definition	Default	Range
#135	IO input filter time width	20.0000	0.001 ~ 9999.999
#136	X axis drive alarm port	0	min=0 -max=18
#137	Y axis drive alarm port	0	min=0 -max=18
#138	Z axis drive alarm port	0	min=0 -max=18
#139	A axis drive alarm port	0	min=0 -max=18
#141	X axis positive limit port	0	min=0 -max=18
#142	Y axis positive limit port	0	min=0 -max=18
#143	Z axis positive limit port	0	min=0 -max=18
#144	A axis positive limit port	0	min=0 -max=18
#146	X axis negative limit port	0	min=0 -max=18
#147	Y axis negative limit port	0	min=0 -max=18
#148	Z axis negative limit port	0	min=0 -max=18
#149	A axis negative limit port	0	min=0 -max=18
#151	X axis Home Signal port"	2	min=0 -max=18
#152	Y axis Home Signal port"	2	min=0 -max=18
#153	Z axis Home Signal port"	2	min=0 -max=18
#154	A axis Home Signal port"	2	min=0 -max=18
#156	Probe Port	13	min=0 -max=18
#157	External emergency stop port	0	min=0 -max=18
#158	Extended Function Key 1 Port	0	min=0 -max=18
#159	Extended Function Key 2 Port	0	min=0 -max=18
#160	Extended Function Key 3 Port	0	min=0 -max=18
#161	Extended Function Key 4 Port	0	min=0 -max=18
#162	X axis drive alarm active electric level	Low	0: Low; 1: High
#163	Y axis drive alarm active electric level	Low	0: Low; 1: High
#164	Z axis drive alarm active electric level	Low	0: Low; 1: High
#165	A axis drive alarm active electric level	Low	0: Low; 1: High
#167	X axis positive limit port active electric level	Low	0: Low; 1: High
#168	Y axis positive limit port active electric level	Low	0: Low; 1: High
#169	Z axis positive limit port active electric level	Low	0: Low; 1: High
#170	A axis positive limit port active electric level	Low	0: Low; 1: High
#172	X axis negative limit port active electric level	Low	0: Low; 1: High
#173	Y axis negative limit port active electric level	Low	0: Low; 1: High
#174	Z axis negative limit port active electric level	Low	0: Low; 1: High
#175	A axis negative limit port active electric level	Low	0: Low; 1: High
#177	X Axis Home active electric level	Low	0: Low; 1: High
#178	Y Axis Home active electric level	Low	0: Low; 1: High
#179	Z Axis Home active electric level	Low	0: Low; 1: High
#180	A Axis Home active electric level	Low	0: Low; 1: High
#182	Probe active electric level	Low	0: Low; 1: High
#183	External emergency stop active electric level	Low	0: Low; 1: High
#184	Extended Function Key 1 active electric level	Low	0: Low; 1: High
#185	Extended Function Key 2 active electric level	Low	0: Low; 1: High
#186	Extended Function Key 3 active electric level	Low	0: Low; 1: High
#187	Extended Function Key 4 active electric level	Low	0: Low; 1: High



## 6. Spindle Parameters

Para#	Parameter Definition	Default	Range	Unit
#188	Spindle interface type	Analog	0: Analog; 1: PUL/DIR	
#189	Spindle mapping axis	A axis	0: X; 1: Y; 2: Z; 3: A	
#190	Default spindle speed	Default	0: G code; 1: Default	
#191	Default spindle speed	12000.0000	min=10.000 -max=99999.000	
#192	Maximum spindle speed	24000.0000	min=99.000 -max=99999.000	
#193	Whether Stop Spindle when pause	Yes	0: No; 1: Yes	
#194	Spindle start-up waiting time	0.0000	min=0.000 -max=99.000	Second
#195	Spindle off waiting time	0.0000	min=0.000 -max=99.000	Second
#412	Automatic spindle shutdown after machining is completed	Yes	0: No; 1: Yes	

## 7. M output code Parameters

Para#	Parameter Definition	Default	Range	Unit
#196	delay time of M8/M9	1.0000	min=0.000 -max=9.000	Second
#197	delay time of M10/M11	1.0000	min=0.000 -max=9.000	Second

www.ddcnc.com

## 8. Home Parameters

Para#	Parameter Definition	Default	Range	Unit
#198	HOME times	1	min=1.000 -max=5.000	
#199	X axis Home direction	Negative	0: Negative; 1: Positive	
#200	Y axis Home direction	Negative	0: Negative; 1: Positive	
#201	Z axis Home direction	Negative	0: Negative; 1: Positive	
#202	A axis Home direction	Negative	0: Negative; 1: Positive	
#204	X axis Home search speed	2000.0000	min=1.000 -max=99999.000	unit/min
#205	Y axis Home search speed	2000.0000	min=1.000 -max=99999.000	unit/min
#206	Z axis Home search speed	2000.0000	min=1.000 -max=99999.000	unit/min
#207	A axis Home search speed	2000.0000	min=1.000 -max=99999.000	unit/min
#209	X axis Home positioning speed	50.0000	min=1.000 -max=99999.000	unit/min
#210	Y axis Home positioning speed	50.0000	min=1.000 -max=99999.000	unit/min
#211	Z axis Home positioning speed	50.0000	min=1.000 -max=99999.000	unit/min
#212	A axis Home positioning speed	50.0000	min=1.000 -max=99999.000	unit/min
#214	X axis Home offset	0.0000	min=-999.000 -max=999.000	unit
#215	Y axis Home offset	0.0000	min=-999.000 -max=999.000	unit
#216	Z axis Home offset	0.0000	min=-999.000 -max=999.000	unit
#217	A axis Home offset	0.0000	min=-999.000 -max=999.000	unit
#219	X axis back distance after Home	10.0000	min=0.000 -max=99.000	unit
#220	Y axis back distance after Home	10.0000	min=0.000 -max=99.000	unit
#221	Z axis back distance after Home	10.0000	min=0.000 -max=99.000	unit
#222	A axis back distance after Home	0.0000	min=0.000 -max=99.000	unit
#224	Home reminder after booting	Yes	0: No; 1: Yes	
#225	Home sequence	ZXYA	0: ZXYA; 1: Sync; 2: ZYXA; 3: YXZA; 4: XYZA	
#413	Check HOME operation before machining	No	0: No; 1: Yes	
#800	X Mach Position of Reference Point 1(G28)	30.0000	min=-9999.000 -max=9999.000	unit
#801	Y Mach Position of Reference Point 1(G28)	-30.0000	min=-9999.000 -max=9999.000	unit
#802	Z Mach Position of Reference Point 1(G28)	10.0000	min=-9999.000 -max=9999.000	unit
#803	A Mach Position of Reference Point 1(G28)	0.0000	min=-9999.000 -max=9999.000	unit
#805	X Mach Position of Reference Point 2(G30 P1))	3.0000	min=-9999.000 -max=9999.000	unit
#806	Y Mach Position of Reference Point 2(G30 P1))	3.0000	min=-9999.000 -max=9999.000	unit
#807	Z Mach Position of Reference Point 2(G30 P1))	3.0000	min=-9999.000 -max=9999.000	unit
#808	A Mach Position of Reference Point 2(G30 P1))	0.0000	min=-9999.000 -max=9999.000	unit
#810	X Mach Position of Reference Point 3 (G30 P2))	4.0000	min=-9999.000 -max=9999.000	unit
#811	Y Mach Position of Reference Point 3 (G30 P2))	4.0000	min=-9999.000 -max=9999.000	unit
#812	Z Mach Position of Reference Point 3 (G30 P2))	4.0000	min=-9999.000 -max=9999.000	unit
#813	A Mach Position of Reference Point 3 (G30 P2))	0.0000	min=-9999.000 -max=9999.000	unit
#815	X Mach Position of Reference Point 4 (G30 P3))	5.0000	min=-9999.000 -max=9999.000	unit
#816	Y Mach Position of Reference Point 4 (G30 P3))	5.0000	min=-9999.000 -max=9999.000	unit
#817	Z Mach Position of Reference Point 4 (G30 P3))	5.0000	min=-9999.000 -max=9999.000	unit
#818	A Mach Position of Reference Point 4 (G30 P3))	0.0000	min=-9999.000 -max=9999.000	unit

#204~#207: DDCS V4.1 added Home search speed of each axis, the users can set as their request.

#209~#212: DDCS V4.1 added Home positioning speed of each axis, when touched the limited switch, its the speed when Exit the Home signal effective area.

## 9. Soft limit Parameters

Para#	Parameter Definition	Default	Range	Unit
#234	Enable software limit	Disable	0: Disable; 1: Enable	
#235	Soft-limited position value of X--	-1200.0000	min=-9999.000 -max=9999.000	unit
#236	Soft-limited position value of Y--	-600.0000	min=-9999.000 -max=9999.000	unit
#237	Soft-limited position value of Z--	-300.0000	min=-9999.000 -max=9999.000	unit
#238	Soft-limited position value of A--	000.0000	min=-9999.000 -max=9999.000	unit
#240	Soft-limited position value of X++	1200.0000	min=-9999.000 -max=9999.000	unit
#241	Soft-limited position value of Y++	600.0000	min=-9999.000 -max=9999.000	unit
#242	Soft-limited position value of Z++	300.0000	min=-9999.000 -max=9999.000	unit
#243	Soft-limited position value of A++	0.0000	min=-9999.000 -max=9999.000	unit

## 10. MPG Parameters

Para#	Parameter Definition	Default	Range	Unit
#061	X axis MPG X1 speed	100.0000	min=0.000 -max=99999.000	unit/min
#062	Y axis MPG X1 speed	100.0000	min=0.000 -max=99999.000	unit/min
#063	Z axis MPG X1 speed	100.0000	min=0.000 -max=99999.000	unit/min
#064	A axis MPG X1 speed	100.0000	min=0.000 -max=99999.000	Degree/min
#066	X axis MPG X10 speed	500.0000	min=0.000 -max=99999.000	unit/min
#067	Y axis MPG X10 speed	500.0000	min=0.000 -max=99999.000	unit/min
#068	Z axis MPG X10 speed	500.0000	min=0.000 -max=99999.000	unit/min
#069	A axis MPG X10 speed	500.0000	min=0.000 -max=99999.000	Degree/min
#071	X axis MPG X100 speed	0.0000	min=0.000 -max=99999.000	unit/min
#072	Y axis MPG X100 speed	0.0000	min=0.000 -max=99999.000	unit/min
#073	Z axis MPG X100 speed	0.0000	min=0.000 -max=99999.000	unit/min
#074	A axis MPG X100 speed	0.0000	min=0.000 -max=99999.000	Degree/min
#076	X axis MPG X1 Acc	3.0000	min=0.000 -max=9999.000	unit/s <sup>2</sup>
#077	Y axis MPG X1 Acc	3.0000	min=0.000 -max=9999.000	unit/s <sup>2</sup>
#078	Z axis MPG X1 Acc	3.0000	min=0.000 -max=9999.000	unit/s <sup>2</sup>
#079	A axis MPG X1 Acc	3.0000	min=0.000 -max=9999.000	Degree/s <sup>2</sup>
#081	X axis MPG X10 Acc	30.0000	min=0.000 -max=9999.000	unit/s <sup>2</sup>
#082	Y axis MPG X10 Acc	30.0000	min=0.000 -max=9999.000	unit/s <sup>2</sup>
#083	Z axis MPG X10 Acc	30.0000	min=0.000 -max=9999.000	unit/s <sup>2</sup>
#084	A axis MPG X10 Acc	30.0000	min=0.000 -max=9999.000	Degree/s <sup>2</sup>
#086	X axis MPG X100 Acc	0.0000	min=0.000 -max=9999.000	unit/s <sup>2</sup>
#087	Y axis MPG X100 Acc	0.0000	min=0.000 -max=9999.000	unit/s <sup>2</sup>
#088	Z axis MPG X100 Acc	0.0000	min=0.000 -max=9999.000	unit/s <sup>2</sup>
#089	A axis MPG X100 Acc	0.0000	min=0.000 -max=9999.000	Degree/s <sup>2</sup>
#245	MPG Precision	0.0040	min=0.001 -max=0.01	
#246	MPG motion direction	Negative	0: Negative; 1: Positive	
#247	MPG control mode	Close	0: Open; 1: Close	
#248	Enable the ESTOP signal on MPG	Enable	0: Disable; 1: Enable	
#249	Electric level of ESTOP on MPG	Low	0: Low; 1: High	

#247: When MPG is on MPG control Mode, the start and stop acceleration speed both cite Start Acceleration speed.

And on MPG control Mode, the controller will send out each pulses that MPG generate; When MPG control mode is close, when stop turning the wheel of MPG, controller just immediately decelerate and stop.

## 11. Extended key Parameters

Para#	Para Definition	Default	Range
#250	Extended key 1 function	Start	0: Start; 1:Pause; 2: XY Zero; 3: Z Zero; 4: Home; 5: Floatting probe; 6: Fixing probe; 7: Vertex probe"; 8: X 1/2; 9: Y 1/2; 10"extkey1.nc; 11: Disable
#251	Extended key 2 function	Pause	0: Start; 1:Pause; 2: XY Zero; 3: Z Zero; 4: Home; 5: Floatting probe; 6: Fixing probe; 7: Vertex probe"; 8: X 1/2; 9: Y 1/2; 10"extkey1.nc; 11: Disable
#252	Extended key 3 function	Disable	0: Start; 1:Pause; 2: XY Zero; 3: Z Zero; 4: Home; 5: Floatting probe; 6: Fixing probe; 7: Vertex probe"; 8: X 1/2; 9: Y 1/2; 10"extkey1.nc; 11: Disable
#253	Extended key 4 function	Disable	0: Start; 1:Pause; 2: XY Zero; 3: Z Zero; 4: Home; 5: Floatting probe; 6: Fixing probe; 7: Vertex probe"; 8: X 1/2; 9: Y 1/2; 10"extkey1.nc; 11: Disable

By #158~#161 to configurate the extended key 1-4 output port number, and by #250~253 to defind the function of the extended key 1-4.

## 12. Backlash Parameters

Para#	Parameter Definition	Default	Range	Unit
#254	enable of X axis backlash	Disable	0: Disable; 1: Enable	
#255	enable of X axis backlash	Disable	0: Disable; 1: Enable	
#256	enable of X axis backlash	Disable	0: Disable; 1: Enable	
#257	enable of X axis backlash	Disable	0: Disable; 1: Enable	
#259	X axis backlash distance	0.9990	min=0.000 -max=0.999	unit
#260	X axis backlash distance	0.0000	min=0.000 -max=0.999	unit
#261	X axis backlash distance	0.0000	min=0.000 -max=0.999	unit
#262	X axis backlash distance	0.0000	min=0.000 -max=0.999	Degree

### 13. Tool offsets Parameters

Para#	Parameter Definition	Default	Range	Unit
#264	H01 tool length	0.0000	min=-999.999 -max=999.999	unit
#265	H02 tool length	0.0000	min=-999.999 -max=999.999	unit
#266	H03 tool length	0.0000	min=-999.999 -max=999.999	unit
#267	H04 tool length	0.0000	min=-999.999 -max=999.999	unit
#268	H05 tool length	0.0000	min=-999.999 -max=999.999	unit
#269	H06 tool length	0.0000	min=-999.999 -max=999.999	unit
#270	H07 tool length	0.0000	min=-999.999 -max=999.999	unit
#271	H08 tool length	0.0000	min=-999.999 -max=999.999	unit
#272	H09 tool length	0.0000	min=-999.999 -max=999.999	unit
#273	H10 tool length	0.0000	min=-999.999 -max=999.999	unit
#274	H11 tool length	0.0000	min=-999.999 -max=999.999	unit
#275	H12 tool length	0.0000	min=-999.999 -max=999.999	unit
#276	H13 tool length	0.0000	min=-999.999 -max=999.999	unit
#277	H14 tool length	0.0000	min=-999.999 -max=999.999	unit
#278	H15 tool length	0.0000	min=-999.999 -max=999.999	unit
#279	H16 tool length	0.0000	min=-999.999 -max=999.999	unit
#280	H01 tool wear	0.0000	min=0.000 -max=999.999	unit
#281	H02 tool wear	0.0000	min=0.000 -max=999.999	unit
#282	H03 tool wear	0.0000	min=0.000 -max=999.999	unit
#283	H04 tool wear	0.0000	min=0.000 -max=999.999	unit
#284	H05 tool wear	0.0000	min=0.000 -max=999.999	unit
#285	H06 tool wear	0.0000	min=0.000 -max=999.999	unit
#286	H07 tool wear	0.0000	min=0.000 -max=999.999	unit
#287	H08 tool wear	0.0000	min=0.000 -max=999.999	unit
#288	H09 tool wear	0.0000	min=0.000 -max=999.999	unit
#289	H10 tool wear	0.0000	min=0.000 -max=999.999	unit
#290	H11 tool wear	0.0000	min=0.000 -max=999.999	unit
#291	H12 tool wear	0.0000	min=0.000 -max=999.999	unit
#292	H13 tool wear	0.0000	min=0.000 -max=999.999	unit
#293	H14 tool wear	0.0000	min=0.000 -max=999.999	unit
#294	H15 tool wear	0.0000	min=0.000 -max=999.999	unit
#295	H16 tool wear	0.0000	min=0.000 -max=999.999	unit
#296	D01 tool diameter	0.0000	min=-99.999 -max=99.999	unit
#297	D02 tool diameter	0.0000	min=-99.999 -max=99.999	unit
#298	D03 tool diameter	0.0000	min=-99.999 -max=99.999	unit
#299	D04 tool diameter	0.0000	min=-99.999 -max=99.999	unit
#300	D05 tool diameter	0.0000	min=-99.999 -max=99.999	unit
#301	D06 tool diameter	0.0000	min=-99.999 -max=99.999	unit
#302	D07 tool diameter	0.0000	min=-99.999 -max=99.999	unit
#303	D08 tool diameter	0.0000	min=-99.999 -max=99.999	unit
#304	D09 tool diameter	0.0000	min=-99.999 -max=99.999	unit
#305	D10 tool diameter	0.0000	min=-99.999 -max=99.999	unit
#306	D11 tool diameter	0.0000	min=-99.999 -max=99.999	unit
#307	D12 tool diameter	0.0000	min=-99.999 -max=99.999	unit
#308	D13 tool diameter	0.0000	min=-99.999 -max=99.999	unit
#309	D14 tool diameter	0.0000	min=-99.999 -max=99.999	unit
#310	D15 tool diameter	0.0000	min=-99.999 -max=99.999	unit
#311	D16 tool diameter	0.0000	min=-99.999 -max=99.999	unit

## 14. System settings

Para#	Parameter Definition	Default	Range	Unit
#312	language setting	简体中文	0: Eng; 1: 简体中文; 2: Custom	
#313	Shift key operation mode	2nd Mode	0: 2nd Mode; 1: Menu Mode	
#316	Tool path paint enable	Enable	0: Disable; 1: Enable	
#317	Tool path paint mode	Statue Mode	0: Statue Mode; 1: Line Mode; 2: 3D Mode	
#318	Tool path page display coordinates	Yes	0: No; 1: Yes	
#319	X axis rotation angle in 3D mode	0.0000	min=-180.0 -max=180.0	degree
#320	Y axis rotation angle in 3D mode	0.0000	min=-180.0 -max=180.0	degree
#321	Z axis rotation angle in 3D mode	0.0000	min=-180.0 -max=180.0	degree
#322	Monitoring page disabled in machining	Yes	0: Yes; 1: No	
#323	Enable of beep	Enable	0: Disable; 1: Enable	
#324	Color reversal	Yes	0: Yes; 1: No	
#325	Disable network functionality	Yes	0: Yes; 1: No	
#326	Obtain IP address automatically	Yes	0: Yes; 1: No	
#327	Local IP address	192.168.2.7		
#328	Net mask	255.255.255.0		
#329	Router IP address	192.168.2.1		
#330	Shared host IP address	192.168.2.8		

Now the available languages are Chinese and English, and we have opened language permissions for the system. Each user can develop a new language pack according to their own needs. There are "custom" and "msg-custom" language packs, the users can and translate and save the new language based on the format of "custom" and "msg-custom".

#313 define the operation mode of the "Shift" Key, when select the 2nd Mode option, the basic functions follow DDCS V3.1, if select the Menu Mode, you can see many new functions added, and the operation is more convenient, it is recommended to choose Menu function options.

#316 Enable of Disable the Tool path paint. When the system is not running smoothly, it is recommended to disable this option, which can effectively reduce memory consumption.

#327~#330 are Ethernet network settings, we already explained in details at Ethercat communication setup chapter.

# 5 G Code and M Code

G code	Description	Description and Example
G0	Rapid positioning	G0 X..Y.. Z.. , move as quickly as possible to a given point. In our system the G0 speed is defined by #103.
G01	Linear interpolation	G1 X... Y... F... , move to a given point by the F speed.
G02	Clockwise circular interpolation	By Radius: G2X..Y..Z..R..F.. By the center of a circle: G2X..Y..Z..I...J..K..F
G03	Counterclockwise circular interpolation	By Radius: G3X..Y..Z..R..F.. By the center of a circle: G3X..Y..Z..I...J..K..F
G04	Pause for a given duration of time	G4 P10000 pause for 10000 millisecond
G15	Switch back to Cartesian coordinates.	G16X10Y90: Moves to (0,10) Y180: Moves to (-10,0) Y270: Moves to (0,-10) Y0 : Moves to (10,0)
G16	Enable Polar Coordinates programming mode X represents the Distance and Y represents the Angle	G15X0Y0: Moves to (0,0) and Polar Coordinates OFF.
G17	XY Plane select	G17, all commands are now to be interpreted in the XY plane
G18	XZ plane select	G18, all commands are now to be interpreted in the XZ plane
G19	YZ plane select	G19, all commands are now to be interpreted in the YZ plane
G20	Inch mode	passed coordinates will be considered as Inches, so internally translated to millimeters
G21	Millimeter mode	passed coordinates will be considered as millimeters
G28	Go to the recorded origin position via a reference point at rapid speed	G91 G28 X10 Y0 Z0 The X axis will first move 10mm to the right, then the XYZ axes will go to the machine axis 0.
G30	Go to the recorded origin position via an alternative reference point at rapid speed	G90G30X_Y_Z_A_P_ P program cites 1,2,3, represents which reference point it will go
G31	Report current Z probe status	G31X_Y_Z_A_L_Q_K_F_ XYZA is the XYZA Probe trip L is the probe signal effective level K represents that disable or enable the hard limit during probing Q represents that when probe signal is triggered the stop mode: 0-Stop by Decelerate 1- Stop immediately F represents the Probing speed  G91G31Z-1000L0Q1K0F100 Z axis probe down 1000mm and the signal effective leve is 0, disable the hard-switch and when probe signal is triggered the stop immediately.
G53	Move in absolute machine coordinate system	Need to Home each axis in advance, or system alarms and exits. G53X10Y10 XY Move to the mach coordiante position (10,10).
G54	G54 coordinate	G54, choose the active coordinate system G54
G55	G55 coordinate	G55, choose the active coordinate system G55
G56	G56 coordinate	G56, choose the active coordinate system G56
G57	G57 coordinate	G57, choose the active coordinate system G57
G58	G58 coordinate	G58, choose the active coordinate system G58
G59	G59 coordinate	G59, choose the active coordinate system G59
G68	ENABLE Rotate program coordinate system	G68X10Y5R45 Rotate 45 degrees around (10,5)
G69	DISABLE Rotate program coordinate system	

G code	Description	Format and description
G73	Canned cycle - peck drilling	Need to configure the spindle as servo spindle. G73 X_Y_Z_R_Q_F_K_; Canned cycle - peck drilling, work with F command. X_Y_ : Hole Position, Z_ : The distance between R position and hole bottom. R_ : The distance between the initial position and R point; Q_ : The drilling depth of each feeding, P_ : Pause time, K_ : Repeated times
G74	Canned cycle - left hand rigid tapping	Need to configure the spindle as servo spindle. G74 CCW rotate to the hole bottom by F speed(Z), and CW rotate to R point. G84 CW rotate to the hole bottom by F speed(Z), and CWW rotate to R point. X_Y_ : Hole Position, Z_ : The distance between R position and hole bottom. R_ : The distance between the initial position and R point; P_ : Pause time G98/G99 G74 X_Y_Z_R_P_F_; G98/G99 G84 X_Y_Z_R_P_F_;
G84	Canned cycle - right hand rigid tapping	Example: M29S200 (Enter the rigid tapping mode. In the rigid tapping mode, the Z axis and servo spindle adopt the interpolation method movements.) G74X-10Y-20Z-30R5F500 (Thread pitch of tap is F/S=500/200=2.5mm) G84X10Y20Z-30R5F500 M5
G90	Absolute distance mode	In absolute distance mode, axis numbers (X, Y, Z, A) usually represent positions in terms of the currently active coordinate system.
G91	Incremental distance mode	In incremental distance mode, IJK numbers usually represent increments Incremental distance mode I from the current controlled point.
G92	Adjust current coordinate	G92X_Y_Z_A_ By adjusting the origin point of the current coordinate system, To make the current point have the coordinates as XYAZ assigned.
G98	Initial level return after canned cycles	Retract perpendicular to the selected plane to the position that axis was in just before the canned cycle started
G99	R-point level return after canned cycles	retract perpendicular to the selected plane to the position indicated by the R word.
G128	Home command	G128X_Y_Z_A_ When programming word (X/Y/Z/A) set to 1, indicate that the according axis execute Home action. G128X1Y1Z1 XYZ axis execute Home action at the same time.



M code	Description	Description and Example
M0	Program Pause	To stop a running program temporarily
M3	Rotate spindle clockwise	To start the spindle turning clockwise at the currently programmed speed
M5	Stop spindle rotation	To stop the spindle from turning
M6	Tool change	M6 Start when the command is encountered. It will then wait for Cycle Start to be pressed
M8	Flood coolant on	Coolant output signal is valid.
M9	All coolant off	Coolant output signal is invalid.
M10	Lubrication ON	Lubrication output signal is valid.
M11	Lubrication OFF	Lubrication output signal is invalid.
M29	Spindle command group command	Enter rigid tapping mode , Call before G74/G84
M98	Call subroutine	To call a subroutine program within the current part program file code.
M99	Return from subroutine	To return from a subroutine program
M30	Program end	End all the program
M105	X axis Home command	If the commands appear on same line, then all the axis execute Home action at the same time. M107 : Z axis Home, M105M106: X axis and Y axis Home.
M106	Y axis Home command	
M107	Z axis Home command	
M108	A axis Home command	
M47	Repeat program from first line	After the program is finished, it will be executed from the beginning, and it will continue to cycle.

## 6 Questions and Answer

Q1: When I power on my controller there is beep and Reset signal is flickering,I pressed Reset button many times but still cannot work normally?

A: 1) Please check if the Reset signal of the MPG is active, you can turn off the MPG Estop Function or reserve the electric level of the MPG Estop;

2) Please check the “External emergency” signal is triggered, you can reserve the electric level.

Q2: I believe all my wiring connections of Input and Output signal are correct, but the signal still is disabled?

A: DDCS V4.1 controller need two power supplies to work properly. One is for controller system one is for IO port. Only when with IO power is supplied, the Input and Output signals and the MPG function can have power to work.

Q3: I believe my wiring connections for the MPG are correct but MPG still doesn' work properly?

A: The MPG need the IO power to work,please check the IO port power supply.

Q4: When I stopped turning the handwheel on MPG,but the machine is still moving?

A : If #247 MPG control mode is Open, the MPG will work in open loop mode. When you turn the handwheel, the system will stores all the pulses that you made, and sends them to the drivers even after you have stopped turning the handwheel. This may lead to crashes. If you want the system to stop when you stop then set parameter #247 MPG control mode is close.

Q5: When I power on the controller,my screen always stay at the Open page?

A: #326 Obtain IP address automatically, if this parameter is active it will brick the controller and stay at open page. Install again the software which include the default setting file and disable #326. Then controller can work normally.

Q6: Why does my controller always s stay stuck at one page, I cannot change it even I do a lot of operations?

A: 1) Same answer for Question 5.

2) If you press the keys too quickly, or enabled #316 Tool path paint, which Causes the controller to crash due to excessive memory usage.

Q7: When I have set the controller language to Eng in the Parameters Page, my controller still displays in Chinese?

A: After setting a new language, please restart your controller, then your controller will display the language which you set.

Q8: In the processing period, nothing happened even after I pressed any buttons.

A: The problem maybe from electromagnetic interference, the solutions are:

1: Don't use the USB cable, just insert the USB memory stick into the controller USB port.

2: The metal part of the USB cable must not touch with the controller box, and also you can use a Ferrite core on the USB cable to try to ignore the noise..

3: The wiring from the inverter to controller, please use the shielded cable, especially the wiring from the servo system to controller, the user must use the shielded cable, to avoid interference.

Q9: Why I can't use many functions which showed in the manual?

A: #313 Shift key operation mode: 2nd Mode or Menu Mode.

When you choose the 2nd Mode, the by the shift key we can find same function content of DDCS V3.1; and in the menu mode, we have added a lot of DDCS New features that are not available in V3.1.

When the #313 parameter is set to menu mode, the shift key will be defined as a menu key, and under each different page, there will be a drop-down menu containing rich functions.

Q10: Why is my toolpath display not compatible with the screen, or is my toolpath display frozen?

A: When you use a new G-code file, and it's the first time the controller runs the file, the toolpath display maybe too small or too big for the screen, if this happens please don't display the toolpath. Just let the controller run through the file completely. After this the controller will know the size of the file, so next time the system can adjust the display accordingly and show a correctly sized toolpath.

Q11: I have checked all the wiring and settings and there is no problem, but the controller still cannot run the G code normally. What information should I provide when contacting the manufacturer so that the manufacturer can help complete the troubleshooting?

A: 1) setting file

2) G code you was running

3) Describe the problem

Send the information above to [info@ddcnc.com](mailto:info@ddcnc.com), the company's technology will test and find out the cause of the failure as soon as possible.

# Keyboard Mapping on DDCS V4.1

When Power on the controller, Keyboard functions are in Mode 1

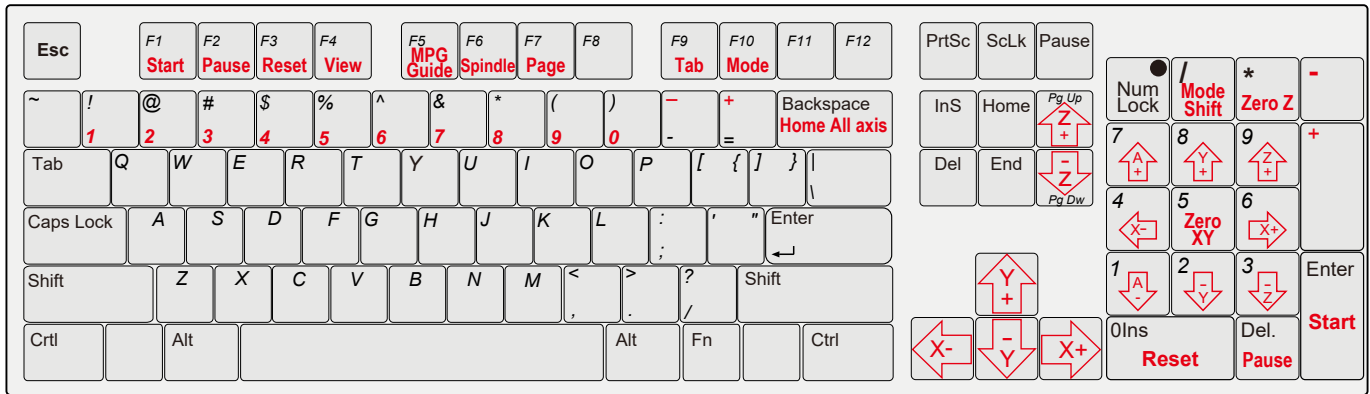

Press “Num Lock” key one time, Keyboard functions turns to Mode 2:

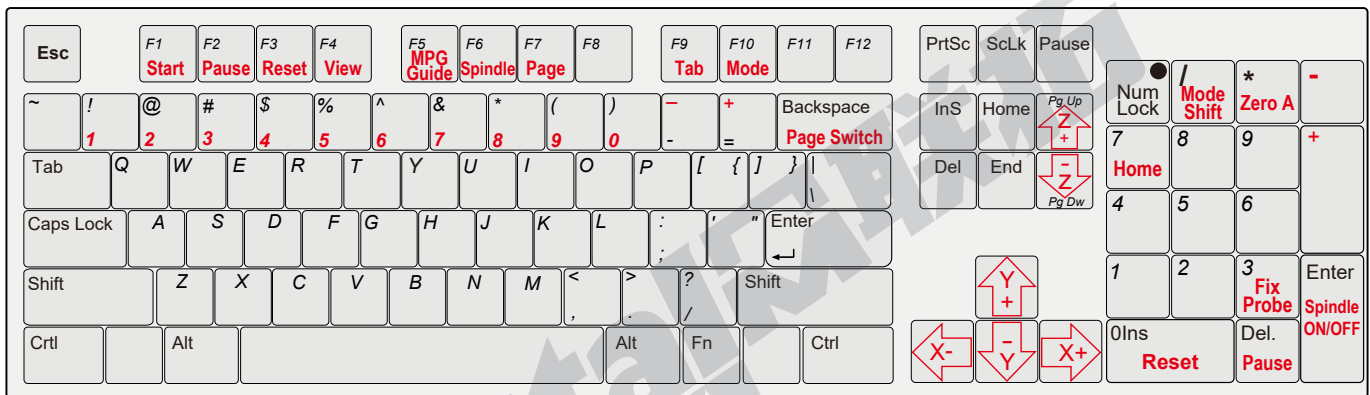

The red icon or text describes the function of the DDCS V4.1 controller.

## Important:

When the 4.1 controller in AUTO mode, use “+” and “-” key to adjust the feed speed (FRO) in 5% increments. When the 4.1 controller in CONT/MPG mode, use “+” and “-” key to adjust the jogging of the machine (JSR) in 5% increments.

When the controller in STEP mode, use “+” and “-” key to shift between 4 Jog step distances.

Press and Hold over 3 seconds the key on the keyboard for the function of Zero Z / Zero XY / Zero A / Fix probe .

The software version must be 2022-11-02 or earlier.



[www.ddcnc.com](http://www.ddcnc.com)